

# Wearable 2D Ring Scanner

- MS652Plus -



**User's Manual**

---

Version 1.4

## Change Log

<b>Date</b>	<b>Change Description</b>	<b>Version</b>
2019/3/21	first published version	1.0
2019/06/21	Update Chapter 2 & 4	1.1
2019/11/07	Update 4.14	1.2
2022/6/20	Update Ch1.1 & 1.2 · update CH2.2.4 "medium delay"	1.3
2022/11/10	Change finger finger pad description	1.4

## Preface

### About This Manual

---

Thank you for purchasing the unitech product. This manual explains how to install, operate and maintain our product. No part of this publication may be reproduced or used in any form, or by any electrical or mechanical means, such as photocopying, recording, or information storage and retrieval systems, without permission in writing from the manufacturer. The material in this manual is subject to change without notice.

### Regulatory Compliance Statements

---



#### FCC Warning Statement

This device has been tested and found to comply with the limits for a Class B digital device, pursuant to part 15 of the FCC rules. These limits are designed to provide reasonable protection against harmful interference in a residential installation. This equipment generates, uses and can radiate radio frequency energy and, if not installed and used in accordance with the instructions, may cause harmful interference with radio communications. However, there is no guarantee that interference will not occur in a particular installation. If this equipment does cause harmful interference with radio or television reception, which can be determined by turning the equipment off and on, the user is encouraged to try to correct the interference by one or more of the following measures:

- Reorient or relocate the receiving antenna.
- Increase the separation between the equipment and receiver.
- Connect the equipment into an outlet on a circuit different from that to which the receiver is connected.
- Consult the dealer or an experienced radio/TV technician for help.

1. This transmitter must not be co-located or operating in conjunction with any other antenna or transmitter.
2. This device complies with FCC RF radiation exposure limits set forth for an uncontrolled environment. To maintain compliance with FCC RF exposure requirements, avoid direct contact to the transmitting antenna during transmitting.
3. Any changes or modifications (including the antennas) made to this device that are not expressly approved by the manufacturer may void the user's authority to operate the equipment.

Operation on the 5.15 - 5.25GHz frequency band is restricted to indoor use only. The FCC requires indoor use for the 5.15-5.25GHz band to reduce the potential for harmful interference to co-channel Mobile Satellite Systems. Therefore, it will only transmit on the 5.25-5.35 GHz, 5.47-5.725 GHz and 5.725 - 5.850 GHz band when associated with an access point (AP).

## **FCC Label Statement**

This device complies with part 15 of the FCC rules. Operation is subject to the following two conditions:

1. This device may not cause harmful interference.
2. This device must accept any interference received, including interference that may cause undesired operation.

## **RF Radiation Exposure Statement**

For body contact during operation, this device has been tested and meets FCC RF exposure guidelines when used with an accessory that contains no metal and that positions the handset a minimum of 1.5 cm from the body. Use of other accessories may not ensure compliance with FCC RF exposure guidelines.

## **Canadian Compliance Statement**

This Class B Digital apparatus meets all requirements of the Canadian Interference-Causing Equipment Regulations.

Cet appareil numérique de la classe B respecte les exigences du Règlement sur le matériel brouilleur du Canada.

## European Conformity Statement

unitech Electronics co., Ltd herewith declares that the unitech product is in compliance with the essential requirements and all other provisions of the RED 2014/53/EU directive, the EMC 2014/30/EU directive and the Low Voltage 2014/35/EU directive.

The declaration of conformity is available for download at :

<https://portal.unitech.eu/public/Safetyregulatorystatement>

## CE RF Exposure Compliance

This device meets EU requirements (2014/53/EU) on the limitation of exposure of the general public to electromagnetic fields by way of health protection.

For body-worn operation, this device has been tested and meets the ICNIRP guidelines and the European Standard EN 62209-2, for use with dedicated accessories, SAR is measured with this device at a separation of 0.5 cm to the body, while transmitting at the highest certified output power level in all frequency bands of this device. Use of other accessories which contain metals may not ensure compliance with ICNIRP exposure guidelines.

## CE Mark Warning



This equipment complies with the requirements of Directive 2014/53/EU of the European Parliament and Commission from 24 May, 2014 governing Radio and Telecommunications Equipment and mutual recognition of conformity.

## RoHS Statement



This device conforms to RoHS (Restriction of Hazardous Substances) European Union regulations that set maximum concentration limits on hazardous materials used in electrical and electronic equipment.

## Waste electrical and electronic equipment (WEEE)



unitech has set up a policy and process to meet the EU directive 2002/96/EC and update 2003/108/EC concerning electronic waste disposal.

For more detailed information of the electronic waste disposal of the products you have purchased from unitech directly or via unitech's resellers, you shall either contact your local supplier or visit us at :

<https://portal.unitech.eu/public/WEEE>

## Taiwan NCC Warning Statement

### 低功率電波輻射性電機管理辦法

第十二條：經型式認證合格之低功率射頻電機，非經許可，公司、商號或使用者均不得擅自變更頻率、加大功率或變更原設計之特性及功能。

第十四條：低功率射頻電機之使用不得影響飛航安全及干擾合法通信；經發現有干擾現象時，應立即停用，並改善至無干擾時方得繼續使用。

前項合法通信，指依電信法規定作業之無線電通信。

低功率射頻電機需忍受合法通信或工業、科學及醫療用電波輻射性電機設備之干擾。

#### 注意事項：

1. 使用過度恐傷害視力。
2. 使用30分鐘請休息10分鐘；2歲以下幼兒不看螢幕，2歲以上每天看螢幕不要超過1小時。
3. 減少電磁波影響，請妥適使用。

## Laser Information

---

The unitech product is certified in the U.S. to conform to the requirements of DHHS/CDRH 21CFR Subchapter J and to the requirements of IEC 825-1. Class II and Class 2 products are not considered to be hazardous. The unitech product contains internally a Visible Laser Diode (VLD) whose emissions do not exceed the maximum limits as set forth in the above regulations. The scanner is designed so that there is no human access to harmful laser light during normal operation, user maintenance or prescribed service operations.

The laser safety warning label required by the DHHS/IEC for the unitech product's optional laser scanner module is located on the memory compartment cover, on the back of the unit.

\* Laser information only applies to the products with laser components.

**CAUTION!** Use of controls or adjustments or performance of procedures other than those specified herein may result in hazardous laser light. Use of optical instruments with the scanner, including binoculars, microscopes, and magnifying glasses, with will increase eye damage. This does not include eyeglasses worn by the user.

## LED Information

---

The unitech product contains LED indicator(s) or LED ring whose luminance is not harmful to human eyes during normal operation, user maintenance or prescribed service operations.

\*LED information only applies to the products with LED components.

## Battery Notice

---

1. To guarantee optimal performance, it is recommended that rechargeable batteries be replaced every year, or after 500 charging cycles are completed. It is normal for the battery to balloon or expand after one year or 500 cycles. Although it does not cause damage, it cannot be used again and must be disposed of according to the location's safe battery disposal procedures.
2. If a battery performance decreases more than 20%, the battery is at the end of its life cycle. Stop use and ensure the battery is disposed of properly.
3. The length of time that a battery lasts depends on the battery type and how the device is used. Conserve the battery life by doing the following:
  - Avoid fully uncharging the battery because this places additional strain on it. Several partial uncharges with frequent charges are better than a fully uncharged battery. Charging a partially charged battery does not cause harm to the unit.
  - Keep the battery cool. Avoid hot vehicles. For prolonged storage, keep the battery at a 40% charge level.
  - Do not leave the battery uncharged and unused for an extended period of time, the battery will wear out and the longevity of the battery will be at least half of one with frequent charges.
4. Protect battery life by not over or under charging the battery.
5. Please do not leave battery unused for long time without charging it. Despite unitech's safety precautions, the battery pack may begin to change shape. If so, stop using it immediately. Please check to see if you are using a proper power adapter to charge the battery or contact your service provider for service.
6. If you cannot charge the battery after it has been idle for an extended period of time and it begins to heat up, please do not try to charge it. It may not be functional anymore.
7. Please only use the original battery from unitech. Using a third party battery can damage our products. Please note that when such damage occurs, it is not covered by your warranty.

**CAUTION!**

- RISK OF EXPLOSION IF BATTERY IS REPLACED INCORRECTLY. DISPOSE OF USED BATTERIES ACCORDING TO THE INSTRUCTIONS.
- 如果更換不正確之電池行事會有爆炸的風險  
請依製造商說明書處理用過之電池
- 如果更換不正確之電池行事會有爆炸的風險  
請依製造商說明書處理用過之電池

## Battery charge notice

It is important to consider temperature when the battery pack is charging. Charging is most efficient at normal room temperature or in a slightly cooler environment. It is essential that batteries are charged within the stated range of 0°C to 40°C. Charging batteries outside of the specified range could damage the batteries and shorten their life cycle.

**CAUTION!** Do not charge batteries at a temperature lower than 0°C. This will and make the batteries unstable and dangerous. Please use a battery temperature detecting device for a charger to ensure a safe charging temperature range.

**CAUTION!** To ensure the unit working properly, please keep all connectors away from the contaminants staying inside of them such as dust, grease, mud, and water. The negligence may cause the unit with no communication, short circuited, overheated and so on.

**CAUTION!** If the connector is damaged, please ensure the connector is being fully repaired before use the unit to avoid causing short circuited.

## Storage and safety notice

Although charged batteries may be left unused for several months, their capacity may be depleted due to build up of internal resistance. If this happens, they will require recharging prior to use. Batteries may be stored at temperatures between -20°C to 60°C, however they may deplete more rapidly at higher temperatures. It is recommended to store batteries at room temperature.

*\* The message above only applies to the usage of the removable batteries.  
For the products with non-removable batteries / without batteries, please refer to the specification of each product.*

## Product Operation and Storage Notice

The unitech product has applicable operation and storage temperature conditions. Please follow the limitation of suggested temperature conditions to avoid failure, damage or malfunction.

*\* For applicable temperature conditions, please refer to the specification of each product.*

## Adapter Notice

---

1. Please do not leave the power adapter in the socket when it is not connected to your unitech product for charging.
2. Please remove the power adapter when the battery is fully recharged.
3. The bundled power adapter that comes with your unitech product is not meant to be used outdoors. An adapter exposed to water or rain, or a very humid environment can cause damage to both the adapter and the product.
4. Please only use the bundled power adapter or same specification of adapter to charge your unitech product. Using the wrong power adapter can damage your unitech product.

*\* The message above only applies to the product connected to the adapter.  
For the products without using the adapters, please refer to the specification of each product.*

## Hearing Damage Warning

---

### Zx.3 Warning

The warning shall be placed on the equipment, or on the packaging, or in the instruction manual and shall consist of the following:

- the symbol of Figure 1 with a minimum height of 5 mm; and
- the following wording, or similar :

To prevent possible hearing damage, do not listen at high volume levels for long periods.



Figure 1 – Warning label (IEC 60417-6044)

Alternatively, the entire warning may be given through the equipment display during use, when the user is asked to acknowledge activation of the higher level.

## Worldwide Support

unitech's professional support team is available to quickly answer questions or assist with technical-related issues. Should an equipment problem occur, please contact the nearest unitech regional service representative.

For complete contact information please visit the Web sites listed below:

<p><b>Taipei, Taiwan – Headquarters</b></p> <p><b>Tel:</b> +886-2-89121122</p> <p><b>E-mail:</b> info@hq.ute.com</p> <p><b>Address:</b> 5F, No. 136, Lane 235, Baoqiao Road, Xindian District, New Taipei City 231, Taiwan (R.O.C.)</p> <p><b>Website:</b> <a href="http://www.ute.com">http://www.ute.com</a></p>	<p><b>Europe</b></p> <p><b>Tel:</b> +31-13-4609292</p> <p><b>E-mail:</b> info@eu.ute.com</p> <p><b>Address:</b> Kapitein Hatterasstraat 19, 5015 BB, Tilburg, the Netherlands</p> <p><b>Website:</b> <a href="http://eu.ute.com">http://eu.ute.com</a></p>
<p><b>China</b></p> <p><b>Tel:</b> +86-59-2310-9966</p> <p><b>E-mail:</b> info@cn.ute.com</p> <p><b>Address:</b> Room401C, 4F, RIHUA International Mansion, Xinfeng 3rd Road, Huoju Hi-tech District, Xiamen, Fujan , China</p> <p><b>Website:</b> <a href="http://cn.ute.com">http://cn.ute.com</a></p>	<p><b>Japan</b></p> <p><b>Tel:</b> +81-3-35232766</p> <p><b>E-mail:</b> info@jp.ute.com</p> <p><b>Address:</b> Kayabacho Nagaoka Building 8F.,1-5-19 Shinkawa, Chuo-Ku, Tokyo, 104-0033, Japan</p> <p><b>Website:</b> <a href="http://jp.ute.com">http://jp.ute.com</a></p>
<p><b>Asia &amp; Pacific / Middle East</b></p> <p><b>Tel:</b> +886-2-27911556</p> <p><b>E-mail:</b> info@apac.ute.com info@india.ute.com info@mideast.ute.com</p> <p><b>Address:</b> 4F., No. 236, ShinHu 2nd Rd., NeiHu Chiu, 114, Taipei,Taiwan</p> <p><b>Website:</b> <a href="http://apac.ute.com">http://apac.ute.com</a> / <a href="http://mideast.ute.com">http://mideast.ute.com</a></p>	<p><b>Latin America</b></p> <p><b>Tel:</b> +52-55-5171-0528</p> <p><b>E-mail:</b> info@latin.ute.com</p> <p><b>Address:</b> 17171 Park Row, Suite 210 Houston, TX 77084USA (Rep.)</p> <p><b>Website:</b> <a href="http://latin.ute.com">http://latin.ute.com</a></p>
<p><b>North America</b></p> <p><b>Tel:</b> +1-714-8926400</p> <p><b>E-mail:</b> info@us.ute.com / info@can.ute.com</p> <p><b>Address:</b> 6182 Katella Ave, Cypress, CA 90630, USA</p> <p><b>Website:</b> <a href="http://us.ute.com">http://us.ute.com</a></p>	<p><b>Please scan QR Code to visit us :</b></p> 

## Warranty Policy

---

The items covered under the unitech Limited Warranty are free from defects during normal use.

The warranty period is varied from each country. Please consult with your supplier or unitech local office for actual length of warranty period to your purchased product.

Warranty becomes void if equipment is modified, improperly installed or used, damaged by accident or neglect, or if any parts are improperly installed or replaced by the user.

## Table of Contents

<b>Preface</b> .....	<b>i</b>
About This Manual .....	i
Regulatory Compliance Statements .....	i
Laser Information .....	vi
LED Information .....	vi
Battery Notice.....	vii
Adapter Notice.....	x
Hearing Damage Warning .....	x
Worldwide Support .....	xi
Warranty Policy .....	xii
<b>Chapter 1 - Overview</b> .....	<b>1</b>
1.1 Package .....	1
1.2 Product Detail.....	3
1.3 Specifications .....	4
1.4 Getting Started .....	7
1.5 Battery Charging .....	12
1.6 Trigger Key Functions.....	12
1.7 LED Indicator / Beeper Sequence .....	13
<b>Chapter 2 - Installation</b> .....	<b>15</b>
2.1 Scanner Type .....	15
2.2 Pairing For The First Time Use.....	15
2.3 How To Unpair .....	17
2.4 Connection .....	18
<b>Chapter 3 – Symbology</b> .....	<b>19</b>
3.1 Set Symbology Defaults .....	19
3.2 UPC/EAN/JAN.....	19
3.3 Code 39.....	45
3.4 Code 93.....	52
3.5 Code 11 .....	55

3.6 Interleaved 2 of 5 (ITF) .....	60
3.7 Discrete 2 of 5 (DTF) .....	68
3.8 Codabar (NW - 7) .....	70
3.9 MSI .....	74
3.10 Chinese 2 of 5 .....	79
3.11 Matrix 2 of 5 .....	79
3.12 Inverse 1D .....	83
3.13 GS1 DataBar .....	84
3.14 Symbology-Specific Security Features .....	90
3.15 Composite .....	95
3.16 2D Symbologies .....	98
3.17 Macro PDF Features .....	105
3.18 Set Bar Codes Enable/Disable .....	112
<b>Chapter 4 – Command Settings</b> .....	<b>113</b>
4.1 General setting .....	113
4.2 Output Data Transmit .....	116
4.3 Beep Tone, Terminator .....	119
4.4 Indicators.....	121
4.5 HID Keyboard Config .....	125
4.6 BT Config .....	128
4.7 Procedure to Update MS652Plus Firmware via USB Drive .....	130
4.8 Procedure to Update MS652Plus Firmware via Bootloader .....	130
4.9 Trigger Mode .....	131
4.10 Picklist Mode .....	133
4.11 Continuous Bar Code Read.....	134
4.12 Unique Bar Code Reporting .....	134
4.13 Mirrored Image .....	135
4.14 Decode Session Timeout.....	136
4.15 Timeout Between Decodes, Same Symbol .....	137
4.16 Timeout Between Decodes, Different Symbols .....	138
4.17 Transmit “No Read” Message.....	139
4.18 Prefix/Suffix Values.....	140
4.19 Scan Data Transmission Format .....	141
4.20 Transmit Code ID Character.....	142
4.21 Miscellaneous Scanner Parameters.....	143

4.22 Low Light Scene Detection.....	144
<b>Appendix A – ASCII Character Sets.....</b>	<b>145</b>
A-1 ASCII Character Set.....	145
A-2 Extended Key Character Set .....	150
<b>Appendix B – Numeric Barcodes .....</b>	<b>151</b>
B-1 Extended Key Character Set .....	151
B-2 Cancel.....	152
<b>Appendix C – Alphanumeric BarCodes .....</b>	<b>153</b>
C-1 Alphanumeric Barcodes.....	153
<b>Appendix D – Programming Reference.....</b>	<b>160</b>
D-1 Symbol Code Identifiers.....	160
D-2 AIM Code Identifiers .....	162

# Chapter 1 - Overview

## 1.1 Package

---

Please make sure the following contents are in the MS652Plus gift box. If something is missing or damaged, please contact your unitech representative.

### The standard package contents:

- MS652Plus Wearable 2D Ring Scanner
- Battery
- Micro USB Cable
- Finger pad

### Accessories

- 800mAh Battery
- Wrist Lanyard
- Micro USB cable
- 4-Slot Battery Charger (optional)
- Trigger module
- 5 slots charging cradle
- Single slot cradle with USB cable
- Power Adaptor with universal plugs
- Single slot cradle with universal power adapter
- Finger Pad

- Changeable Finger Strap
- WD200 3.1 inch Wearable Computer

***NOTE: The barcode with an asterisk (\*) which appears in the following chapters indicates that it is the default option for the corresponding setting.***

## 1.2 Product Detail

---

### ■ Scanner Detail

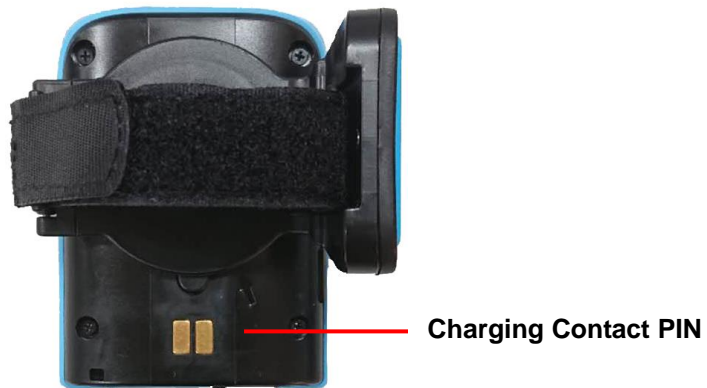

## 1.3 Specifications

<b>System</b>	
Connection	Connect to host with Windows, Android, or iOS
Memory	7.5Mbytes, store up to 590,000 of EAN13 codes
Keys	1x trigger key
<b>Optical &amp; Performance</b>	
Scan Engine	Zebra SE2707
Sensor	CMOS sensor with 640 x 400 pixel
Light Source	1 Hyper Red 660nm LED
Ambient Light	Max 107, 639 lux (direct sunlight)
Skew Angle	60 degrees
Pitch Angle Sensor	60 degrees
Printing Contrast Scale	minimum 20%
Depth of Field(DOF PCS=80%)	SYMBOLGY / X-DIM TYPICAL RANGE* 5 mil Code 39 2.0 in / 5.1 cm 6.4 in / 16.2 cm 5 mil Code 128 2.5 in / 6.3 cm 5.0 in / 12.7 cm 6.6 mil PDF417 2.5 in / 6.3 cm 6.3 in / 16.0 cm 10 mil PDF417 1.8 in / 4.5 cm* 9.0 in / 22.8 cm 13 mil 100% UPC 2.0 in / 5.0 cm* 12.5 in / 31.7 cm 20 mil Code 39 2.0 in / 5.0 cm* 19.5 in / 49.5 cm 20 mil Data Matrix 1.5 in / 3.8 cm 13.5 in / 34.3 cm 20 mil QR Code 1.5 in / 3.8 cm 11.0 in / 27.9 cm
<b>Communication</b>	
Radio Frequency	Bluetooth® 4.2 Bluetooth® V2.1
Range	30ft/10M (line of sight)
Host Interface supported	USB

Protocol	HID / SPP
<b>Mechanical</b>	
Scanner Dimension	50 x 71 x 21 mm
Scanner Weight	95g
Trigger Switch Life	1 million times
<b>Functionality</b>	
Symbologies	1D: All major symbologies and PDF417 2D: QR Code, Data Matrix, Aztec Code, PDF417, Macro PDF417, Micro PDF417, MaxiCode, Codablock A, Codablock F, GS1Composite, Han Xin Code, Australian Post, British Post, Canadian Pos, InfoMail, Intelligent Mail Bar Code, Japanese Post, KIX (Netherlands) Post, GS1 Composite, Korea Post, Planet Code, Postal, Postnet
Operation Mode	Trigger mode, Presentation mode, Auto mode, Batch mode
Data Formatting	Prefix, Suffix, Code ID, Reformatting Date
<b>Electrical</b>	
Operation Voltage	DC 5V
Current Consumption	Operation mode: 400 mA, Standby mode: 160 mA
Battery Type	Rechargeable Lithium-ion
Battery Capacity	800mAH
Charging Time	Fully charged in 4 hours
Operating Time	
Charging Method	USB Cable or Battery Charging cradle
<b>Environmental</b>	
ESD Protection	Functional after 8K Contact and 12K Air
Mechanical Shock	1.5M onto concrete (scanner only)
Operating Temperature	0°C to 50°C ( 32°F to 122°F )

Storage Temperature	-20°C to 60°C ( -4°F to 140°F )
Relative Humidity	95% non-condensing
IP Rating	IP42
<b>Regulatory Approvals</b>	
CE, FCC, BSMI, VCCI, TELEC, NCC, BQB	

## 1.4 Getting Started

---

### 1.4.1 How to disassemble the trigger module

Simply use your finger to press down the release button and rotate it counterclockwise to remove the trigger module.

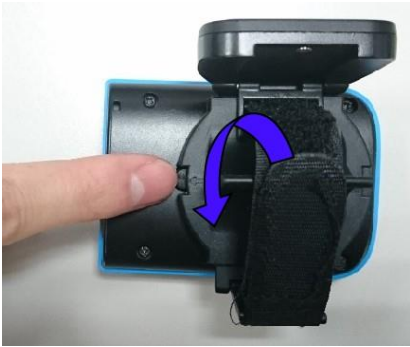

### 1.4.2 How to assemble the trigger module

Step .1 Find the release button on MS652Plus



Step 2. Align the four grooves from the trigger module with MS652Plus, also make sure arrows from both sides are close together. Please adjust the arrow alignment as shown in the photo below.

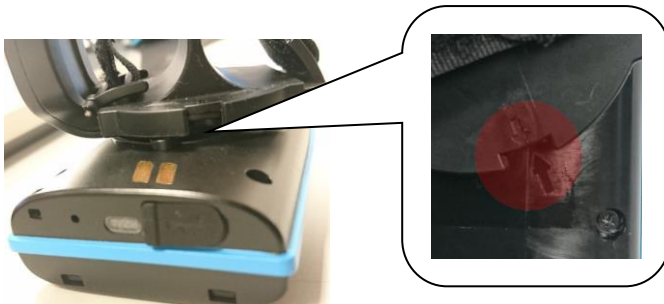

## MS652Plus User's Manual

Then use the trigger module to press down the release button and rotate it clockwise until you hear a clicking sound and the button stays in between the gap of the trigger module. And MS652Plus is ready to go.

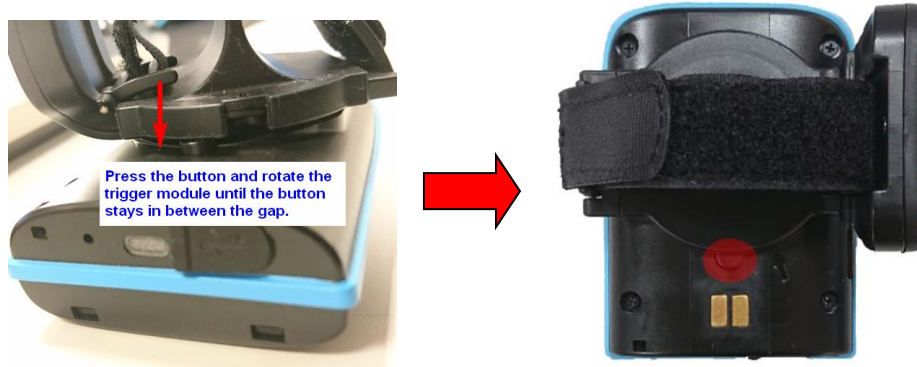

For hand preference, there are two gaps for users to swap the trigger key location for left click or right click.



**Right handed users**  
(trigger key is on the left )



**Left handed users**  
(trigger key is on the right )



### 1.4.3 How to change finger pad

There are two finger pads for users to choose in order to adjust fingers in a comfortable way.



Step 1: Paste two finger pads together

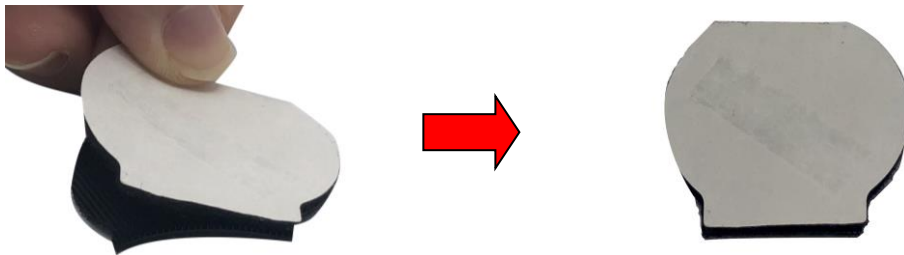

Step 2: Remove the release paper from the finger pad, and paste it on the trigger module.

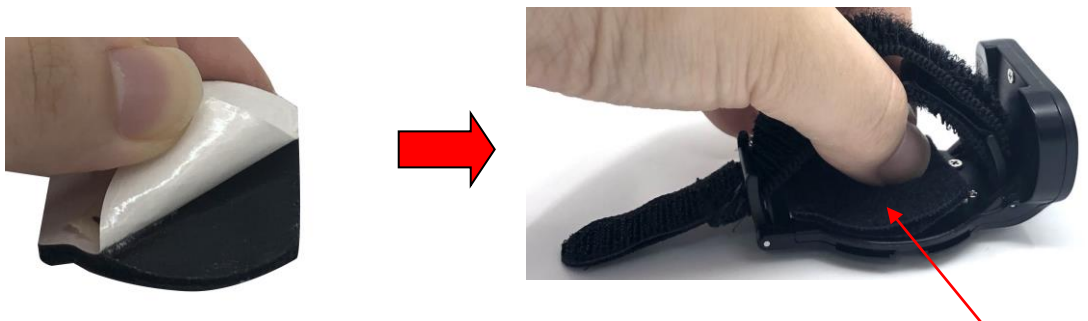

## 1.4.4 How to change the battery

Step 1 : Use your thumb to press down the latch, the battery will automatically jump out, and then you can remove the battery.



Step 2 : To install the battery, slide the battery and press down the battery to secure it until you hear the clicking sound.



## 1.4.5 How to put on MS652Plus

Step 1. Pull open the velcro band and insert your index finger and middle finger through the loop.

Step 2. Adjust and tighten the velcro band for a comfortable fit.

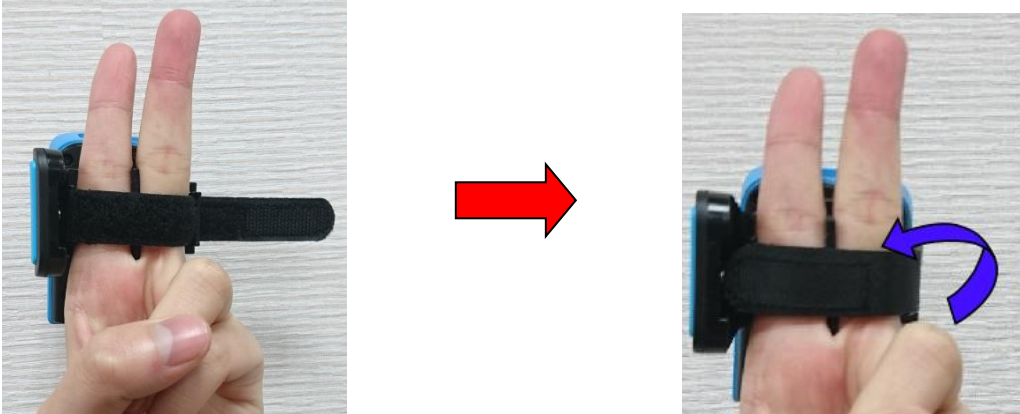

Step 3. Clench your fist and use your thumb to tap the trigger key.



Step 4. Aim at the barcode you wish to scan.



## 1.5 Battery Charging

---

1. Flip open the micro USB port on the scanner.
2. Insert the micro USB connector into the port on the scanner and USB A connector into a USB port on the host PC.
3. Keep charging until the red LED indicator turns off.

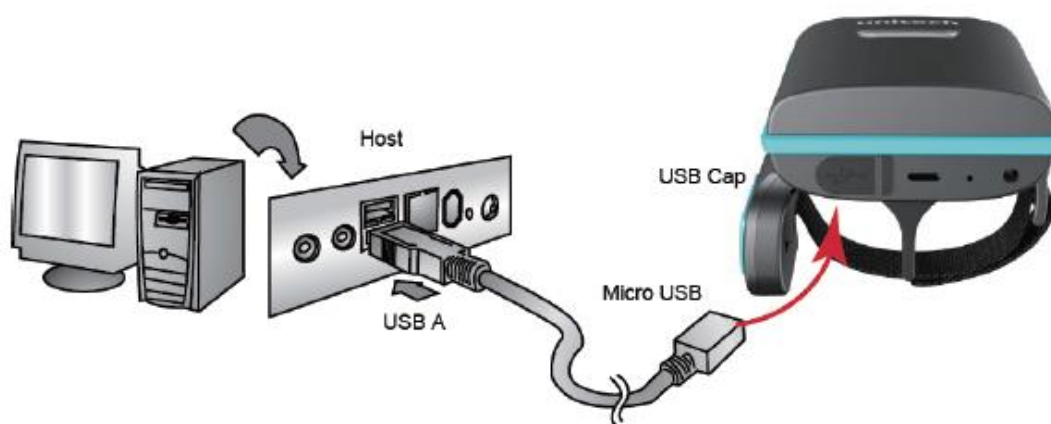

## 1.6 Trigger Key Functions

---

1. Power On: Press & Hold > 1 second
2. Power On & Enter BT Pairing Mode: Press & Hold > 5 seconds
3. Power Off: Press & Hold for 5 seconds until you hear a beep.
4. Connect USB drive to host: Double click with USB cable connected
5. Disconnect USB drive: Double click or press & hold for 2 seconds

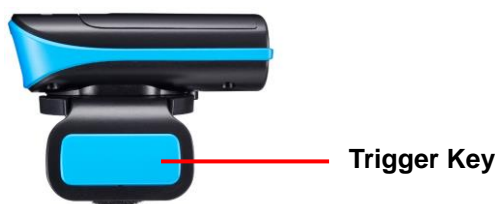

## 1.7 LED Indicator / Beeper Sequence

---

Action/Status	LED Status
Battery charging	Red LED on
Battery Low < 15%	Red LED blinking every 2 seconds
Battery Low < 5%	Red LED blinking fast with all other LED indicators disabled
System Warning /Error	Red LED toggling every second for 5 seconds or until scan button pressed
BT is paired and disconnected to the host	Green LED on
Scanner in Presentation Mode	Green LED blinking every 2 seconds
System busy with data scanning disabled	Green LED toggling every second
BT is connected to host & ready to send data	Blue LED on
USB drive connected	White LED (Red + Green + Blue) toggling every second
Good read	Green LED flashing once
BT in pairing mode	Blue LED toggling every second

Action/Status	Beep / Sound
Auto Operation Mode	Power On with 1 Beep
Wedge Operation Mode	Power On with 2 Beeps
Batch Operation Mode	Power On with 3 Beeps
Auto Power Off Alarm	3 short beeps at 15 seconds before power off
Power Off	Short beep
Good Read with BT Connected	Beep with medium sound
USB Drive Connection	Beep with low-medium-high sound
USB Drive Disconnection	Beep with high-medium-low sound
System Setting with Shorter Processing Time	Beep with high-low sound
System Setting with Longer Processing Time	One beep each with high-low sound at the beginning & end of the setting
System Warning /Error	Beep with high-low-high-low-high sound
Good Read with BT Disconnected (Wedge Mode)	Beep with high-low-high-low-high system warning sound
Good Read with BT Disconnected (Auto & Batch modes)	Beep with medium-high sound
BT Disconnection	Beep with high-medium-low sound
BT Connection	Beep with low-medium-high sound
USB Cable Plug /Unplug	Short beep

## Chapter 2 - Installation

### 2.1 Scanner Type

---



### 2.2 Pairing For The First Time Use

---

#### 2.2.1 NFC Pairing with Mobile Devices

**( only applicable in BT HID Mode)**

- Step 1.** Ensure your mobile device supports NFC and that it is enabled.
- Step 2.** MS652Plus will automatically enter BT pairing mode.
- Step 3.** Turn both NFC & Bluetooth on your mobile device.
- Step 4.** Touch near the unitech logo area of the MS652Plus scanner to your mobile phone, until the device prompts to accept pairing.
- Step 5.** Press ok to respond your Bluetooth pairing request.
- Step 6.** MS652Plus is now connected to your mobile phone.



*NFC tag is embedded on the backside of housing nearby unitech logo*



## 2.2.2 Pairing with Mobile Devices (w/o NFC)

- Step 1.** Go to your host device settings and turn the Bluetooth function on.
- Step 2.** MS652Plus will automatically enter BT pairing mode.
- Step 3.** The MS652Plus will appear on your device as "MS652Plus-XXXX."
- Step 4.** Select "MS652Plus-XXXX."
- Step 5.** Open a word processing program such as Microsoft Word or Notepad and scan the following barcode. If the word "unitech" appears on the screen you have successfully installed your scanner.



## 2.2.3 Establishing BT connection in BT SPP

BT SPP



- Step 1.** Use MS652Plus to scan **BT SPP** barcode.
- Step 2.** It will automatically enter BT pairing mode.
- Step 3.** Double-click **Bluetooth® Device** icon in the toolbar on your PC. Select **Add New Devices**. When you see a device list windows, choose MS652Plus-XXXX and then press **Next**.
- Step 4.** When PC is establishing a BT connection in **BT SPP** mode with MS652Plus, windows system will automatically install the required drivers.
- Step 5.** Back to your PC toolbar, right click on the **Bluetooth® Device** icon, choose **Open Settings**. Go to **COM Port** page and select in-coming COM port ;for example **COM 28**.
- Step 6.** MS652Plus will beep when your PC successfully establish a BT connection with MS652Plus.
- Step 7.** Please download Tera Term terminal emulator application from [http://www.ute.com/products\\_info.php?pc1=3&pc2=401&rbu=0&pid=2388](http://www.ute.com/products_info.php?pc1=3&pc2=401&rbu=0&pid=2388) and then install to you PC.

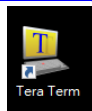

## 2.3 How To Unpair

---

Scan below bar code to unpair MS652Plus with one device before pairing with another new device.

1. If MS652Plus is connected to a host, un-pair will not work. Please remove pairing or turn bluetooth® off from the host side first & try again.
2. If there is trouble to remove pairing on host device, turn off MS652Plus & try again. After pairing on host is removed, scan 'BLE Un-Pair/Pair' for new pairing.

BT/BLE Un-Pair / Pair



## 2.4 Connection

---

### 2.4.1 To Synchronize Date & Time with Host

- Step 1. Connect MS652Plus as USB drive to host
- Step 2. Open file 'Config.txt'
- Step 3. Use 'Save As' to save file 'Config.txt' without name change to USB Drive
- Step 4. Eject/Disconnect USB drive from host

### 2.4.2 Rename device

- Step 1. Connect MS652Plus as USB drive to host
- Step 2. Open file 'Config.txt'
- Step 3. Change default device name <DEVICE\_NAME> = "MS652Plus\_XXXX" to <DEVICE\_NAME> = "New\_Device\_Name"
- Step 4. Max. device name length is 16 characters
- Step 5. Save file 'Config.txt'
- Step 6. Eject/Disconnect USB drive from host

## Chapter 3 – Symbology

### 3.1 Set Symbology Defaults

---

If you have tried to scan “Factory Default” setting barcode but the scanner still cannot perform properly and please scan “**Set Symbology Defaults**” clears all custom default values and sets the engine default values.

Set Symbology Defaults

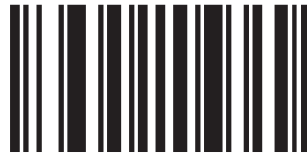

### 3.2 UPC/EAN/JAN

---

#### 3.2.1 UPC-A

Scan one of the following bar codes to enable or disable UPC-A.

Enable UPC-A\*



Disable UPC-A



### 3.2.2 UPC-E

Scan one of the following bar codes to enable or disable UPC-E.

Enable UPC-E\*



Disable UPC-E



### 3.2.3 UPC-E1

Scan one of the following bar codes to enable or disable UPC-E1.

*NOTE : UPC-E1 is not a UCC (Uniform Code Council) approved symbology.*

Enable UPC-E1



Disable UPC-E1\*

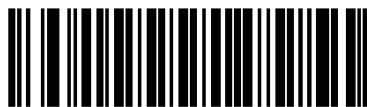

### 3.2.4 EAN-8/JAN-8

Scan one of the following bar codes to enable or disable EAN-8/JAN-8.

Enable EAN-8/JAN-8\*



Disable EAN-8/JAN-8



### 3.2.5 EAN-13/JAN-13

Scan one of the following bar codes to enable or disable EAN-13/JAN-13.

Enable EAN-13/JAN-13\*



Disable EAN-13/JAN-13



### 3.2.6 Bookland EAN

Scan one of the following bar codes to enable or disable Bookland EAN.

**Enable Bookland EAN**



**Disable Bookland EAN\***



### 3.2.7 Bookland ISBN Format

If you enabled Bookland EAN, select one of the following formats for Bookland data:

- **Bookland ISBN-10** - The engine reports Bookland data starting with 978 in traditional 10-digit format with the special Bookland check digit for backward-compatibility. Data starting with 979 is not considered Bookland in this mode.
- **Bookland ISBN-13** - The engine reports Bookland data (starting with either 978 or 979) as EAN-13 in 13-digit format to meet the 2007 ISBN-13 protocol.

**Bookland ISBN-10\***



**Bookland ISBN-13**



### 3.2.8 ISSN EAN

Scan one of the following bar codes to enable or disable ISSN EAN.

**Enable ISSN EAN**



**Disable ISSN EAN \***



### 3.2.9 Decode UPC/EAN/JAN Supplementals

**Decode UPC/EAN/JAN With Supplementals Only**



**Ignore UPC/EAN/JAN Supplementals \***



**Autodiscriminate UPC/EAN/JAN with Supplementals**



**Enable 378/379 Supplemental Mode**



**Enable 978/979 Supplemental Mode**



**Enable 977 Supplemental Mode**



**Enable 414/419/434/439 Supplemental Mode**



**Enable Smart Supplemental Mode**



**Supplemental User-Programmable Type 1 and 2**



**Smart Supplemental Plus User-Programmable 1 and 2**



**Smart Supplemental Plus User-Programmable 1**



**Supplemental User-Programmable Type 1**



**Enable 491 Supplemental Mode**



### 3.2.10 User-Programmable Supplementals

If you selected a Supplemental User-Programmable option, scan User-Programmable Supplemental 1, and then scan three bar codes from [Appendix B, Numeric Bar Codes](#) to set the 3-digit prefix.

To set a second 3-digit prefix, scan User-Programmable Supplemental 2, and then scan three bar codes from [Appendix B, Numeric Bar Codes](#). The default is 000 (zeroes).

#### User-Programmable Supplemental 1



#### User-Programmable Supplemental 2



### 3.2.11 UPC/EAN/JAN Supplemental

#### Redundancy

If you selected Autodiscriminate UPC/EAN/JAN with Supplementals, this option sets the number of times to decode a symbol without supplementals before transmission. The range is from 2 to 16. Five or above is recommended when decoding a mix of UPC/EAN/JAN symbols with and without supplementals. The default is 10. To set a redundancy value, scan the following bar code, and then scan two bar codes from [Appendix B, Numeric Bar Codes](#). Enter a leading zero for single digit numbers. To correct an error or change a selection, [scan Cancel](#).

#### UPC/EAN/JAN Supplemental Redundancy



## 3.2.12 UPC/EAN/JAN Supplemental AIM ID

### Format

If Transmit Code ID Character is set to AIM Code ID Character, scan one of the following bar codes to select an output format when reporting UPC/EAN/JAN bar codes with supplementals:

- **Separate** - Transmit UPC/EAN/JAN with supplementals with separate AIM IDs but one transmission, i.e., ]E<0 or 4><data>]E<1 or 2>[supplemental data]
- **Combined** – Transmit UPC/EAN/JAN with supplementals with one AIM ID and one transmission, i.e., ]E3<data+supplemental data>
- **Separate Transmissions** - Transmit UPC/EAN/JAN with supplementals with separate AIM IDs and separate transmissions, i.e.,  
]E<0 or 4><data>  
]E<1 or 2>[supplemental data]

#### Separate



#### Combined\*



#### Separate Transmissions



### 3.2.13 Transmit UPC-A Check Digit

The check digit is the last character of the symbol used to verify the integrity of the data. Scan one of the following bar codes to transmit the bar code data with or without the UPC-A check digit. It is always verified to guarantee the integrity of the data.

Transmit UPC-A Check Digit \*



Do Not Transmit UPC-A Check Digit

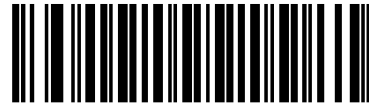

### 3.2.14 Transmit UPC-E Check Digit

The check digit is the last character of the symbol used to verify the integrity of the data. Scan one of the following bar codes to transmit the bar code data with or without the UPC-E check digit. It is always verified to guarantee the integrity of the data.

Transmit UPC-E Check Digit \*

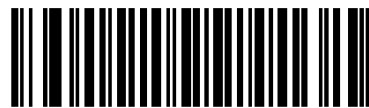

Do Not Transmit UPC-E Check Digit

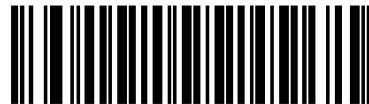

### 3.2.15 Transmit UPC-E1 Check Digit

The check digit is the last character of the symbol used to verify the integrity of the data. Scan one of the following bar codes to transmit the bar code data with or without the UPC-E1 check digit. It is always verified to guarantee the integrity of the data.

**Transmit UPC-E1 Check Digit \***

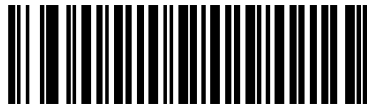

**Do Not Transmit UPC-E1 Check Digit**

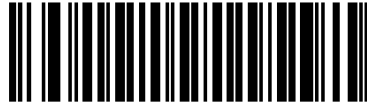

### 3.2.16 UPC-A Preamble

Preamble characters are part of the UPC symbol, and include Country Code and System Character. Select the appropriate option for transmitting a UPC-A preamble to match the host system:

- Transmit System Character only
- Transmit System Character and Country Code ("0" for USA)
- Transmit no preamble.

No Preamble (<DATA>)



System Character (<SYSTEM CHARACTER> <DATA>)\*

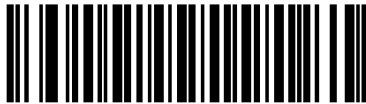

System Character & Country Code(< COUNTRY CODE>  
<SYSTEM CHARACTER> <DATA>)

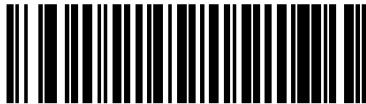

### 3.2.17 UPC-E Preamble

Preamble characters are part of the UPC symbol, and include Country Code and System Character. Select the appropriate option for transmitting a UPC-E preamble to match the host system:

- Transmit System Character only
- Transmit System Character and Country Code ("0" for USA)
- Transmit no preamble.

**No Preamble (<DATA>)**



**System Character (<SYSTEM CHARACTER> <DATA>)\***



**System Character & Country Code(< COUNTRY CODE>  
<SYSTEM CHARACTER> <DATA>)**



### 3.2.18 UPC-E1 Preamble

Preamble characters are part of the UPC symbol, and include Country Code and System Character. Select the appropriate option for transmitting a UPC-E1 preamble to match the host system:

- Transmit System Character only
- Transmit System Character and Country Code ("0" for USA)
- Transmit no preamble.

**No Preamble (<DATA>)**



**System Character (<SYSTEM CHARACTER> <DATA>)\***



**System Character & Country Code(< COUNTRY CODE>  
<SYSTEM CHARACTER> <DATA>)**



### 3.2.19 Convert UPC-E to UPC-A

Enable this to convert UPC-E (zero suppressed) decoded data to UPC-A format before transmission. After conversion, the data follows UPC-A format and is affected by UPC-A programming selections (e.g., Preamble, Check Digit).

Disable this to transmit UPC-E decoded data as UPC-E data, without conversion.

**Convert UPC-E to UPC-A (Enable)**



**Do Not Convert UPC-E to UPC-A (Disable)\***

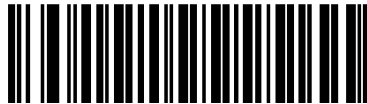

### 3.2.20 Convert UPC-E1 to UPC-A

Scan **Convert UPC-E1 to UPC-A (Enable)** to convert UPC-E1 decoded data to UPC-A format before transmission. After conversion, the data follows UPC-A format and is affected by UPC-A programming selections (e.g., Preamble, Check Digit). Scan **Do Not Convert UPC-E1 to UPC-A (Disable)** to transmit UPC-E1 decoded data as UPC-E1 data, without conversion.

**Convert UPC-E1 to UPC-A (Enable)**



**Do Not Convert UPC-E1 to UPC-A (Disable)\***



### 3.2.21 EAN/JAN Zero Extend

Scan **Enable EAN/JAN Zero Extend** to add five leading zeros to decoded EAN-8 symbols to make them compatible in length to EAN-13 symbols.

Scan **Disable EAN/JAN Zero Extend** to transmit EAN-8 symbols as is.

**Enable EAN/JAN Zero Extend**



**Disable EAN/JAN Zero Extend\***



### 3.2.22 UCC Coupon Extended Code

Scan **Enable UCC Coupon Extended Code** to decode UPC-A bar codes starting with digit '5', EAN-13 bar codes starting with digit '99', and UPC-A/GS1-128 coupon codes. UPC-A, EAN-13, and GS1-128 must be enabled to use this feature.

**Enable UCC Coupon Extended Code**



**Disable UCC Coupon Extended Code\***



### 3.2.23 Coupon Report

Scan one of the following bar codes to select the type of coupon format to support.

- **Old Coupon Format** - Support UPC-A/GS1-128 and EAN-13/GS1-128.
- **New Coupon Format** - An interim format to support UPC-A/GS1-DataBar and EAN-13/GS1-DataBar.
- **Autodiscriminate Format** - Support both Old Coupon Format and New Coupon Format.

#### Old Coupon Format



#### New Coupon Format\*



#### Auto discriminate Coupon Format



### 3.2.24 UPC Reduced Quiet Zone

Scan one of the following bar codes to enable or disable decoding UPC bar codes with reduced quiet zones (the margins on either side of the bar code). If you select **Enable**, select a [1D Quiet Zone Level](#).

**Enable UPC Reduced Quiet Zone**



**Disable UPC Reduced Quiet Zone\***



### 3.2.25 Code 128

Scan one of the following bar codes to enable or disable Code 128.

**Enable Code 128\***



**Disable Code 128**



### 3.2.25.1 Set Lengths for Code 128

The length of a code refers to the number of characters (i.e., human readable characters), including check digit(s) the code contains. Set lengths for Code 128 to any length, one or two discrete lengths, or lengths within a specific range. The default is **Any Length**.

*NOTE: When setting lengths, enter a leading zero for single digit numbers.*

Scan one of the following bar codes to select a length option:

- **One Discrete Length** - Decode only Code 128 symbols containing a selected length. Select the length using the bar codes in [Appendix B, Numeric Bar Codes](#). For example, to decode only Code 128 symbols with 14 characters, scan Code 128 - One Discrete Length, and then scan 1, 4. To correct an error or change the selection, [scan Cancel](#).
- **Two Discrete Lengths** - Decode only Code 128 symbols containing either of two lengths. Select lengths using the bar codes in [Appendix B, Numeric Bar Codes](#). For example, to decode only Code 128 symbols containing either 2 or 14 characters, scan Code 128 - Two Discrete Lengths, and then scan 0, 2, 1, 4. To correct an error or change the selection, [scan Cancel](#).
- **Length Within Range** - Decode Code 128 symbols with a specific length range. Select lengths using the bar codes in [Appendix B, Numeric Bar Codes](#). For example, to decode Code 128 symbols containing between 4 and 12 characters, scan Code 128 - Length Within Range, and then scan 0, 4, 1, 2. To correct an error or change the selection, [scan Cancel](#).
- **Any Length** - Decode Code 128 symbols containing any number of characters within the engine's capability.

### 3.2.26 Set Lengths for Code 128

Code 128 - One Discrete Length



Code 128 - Two Discrete Lengths



Code 128 - Length Within Range



Code 128 - Any Length\*



### 3.2.27 GS1-128 (formerly UCC/EAN-128)

Scan one of the following bar codes to enable or disable GS1-128.

Enable GS1-128\*



Disable GS1-128



### 3.2.28 ISBT 128

ISBT 128 is a variant of Code 128 used in the blood bank industry. Scan one of the following bar codes to enable or disable ISBT 128.

Enable ISBT 128\*



Disable ISBT 128



### 3.2.29 ISBT Concatenation

Select an option for concatenating pairs of ISBT code types:

- **Enable ISBT Concatenation** –

There must be two ISBT codes in order for the engine to decode and perform concatenation. The engine does not decode single ISBT symbols.

- **Disable ISBT Concatenation** –

The engine does not concatenate pairs of ISBT codes it encounters.

- **Autodiscriminate ISBT Concatenation** –

The engine decodes and concatenates pairs of ISBT codes immediately. If only a single ISBT symbol is present, the engine must decode the symbol the number of times set via ISBT Concatenation Redundancy before transmitting its data to confirm that there is no additional ISBT symbol.

**Enable ISBT Concatenation**



**Disable ISBT Concatenation\***



**Autodiscriminate ISBT Concatenation**

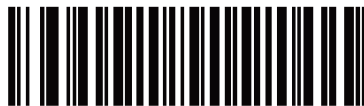

### 3.2.30 Check ISBT Table

The ISBT specification includes a table that lists several types of ISBT bar codes that are commonly used in pairs. If you set **ISBT Concatenation to Enable**, enable **Check ISBT Table** to concatenate only those pairs found in this table. Other types of ISBT codes are not concatenated.

Enable Check ISBT Table\*



Disable Check ISBT Table



### 3.2.31 ISBT Concatenation Redundancy

If you set ISBT Concatenation to Autodiscriminate (the default), use this parameter to set the number of times the engine must decode an ISBT symbol before determining that there is no additional symbol. Scan the following bar code, and then scan bar codes in [Appendix B, Numeric Bar Codes](#) to set a value between 2 and 20. Enter a leading zero for single digit numbers. To correct an error or change a selection, [scan Cancel](#). The default is 10.

ISBT Concatenation Redundancy



### 3.2.32 Code 128 <FNC4>

This feature applies to Code 128 bar codes with an embedded <FNC4> character. Select **Ignore Code 128 <FNC4>** to strip the <FNC4> character from the decode data. The remaining characters are sent to the host unchanged. When disabled, the <FNC4> character is processed normally as per Code 128 standard.

**Honor Code 128 <FNC4>\***



**Ignore Code 128 <FNC4>**



### 3.2.33 Code 128 Security Level

Code 128 bar codes are vulnerable to misdecodes, particularly when Code 128 Lengths is set to **Any Length**. The engine offers four levels of decode security for Code 128 bar codes. There is an inverse relationship between security and engine aggressiveness. Increasing the level of security can reduce scanning aggressiveness, so select only the level of security necessary.

- **Code 128 Security Level 0** - The engine operates in its most aggressive state, while providing sufficient security in decoding most in-spec bar codes.
- **Code 128 Security Level 1** - This option eliminates most misdecodes while maintaining reasonable aggressiveness.
- **Code 128 Security Level 2** - This option applies greater bar code security requirements if Security Level 1 fails to eliminate misdecodes.
- **Code 128 Security Level 3** - If you selected Security Level 2, and misdecodes still occur, select this security level to apply the highest safety requirements.

*NOTE: Selecting this option is an extreme measure against mis-decoding severely out-of-spec bar codes, and significantly impairs the decoding ability of the engine. If this level of security is required, try to improve the quality of the bar codes.*

### 3.2.34 Code 128 Security Level (continued)

Code 128 Security Level 0



Code 128 Security Level 1\*



Code 128 Security Level 2



Code 128 Security Level 3



### 3.2.35 Code 128 Reduced Quiet Zone

Scan one of the following bar codes to enable or disable decoding Code 128 bar codes with reduced quiet zones (the margins on either side of the bar code). If you select Enable, select a [1D Quiet Zone Level](#).

#### Enable Code 128 Reduced Quiet Zone



#### Disable Code 128 Reduced Quiet Zone\*



## 3.3 Code 39

---

### 3.3.1 Code 128 Reduced Quiet Zone

Scan one of the following bar codes to enable or disable Code 39.

Enable Code 39\*

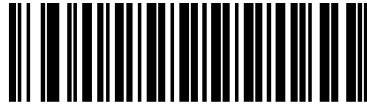

Disable Code 39



### 3.3.2 Trioptic Code 39

Trioptic Code 39 is a variant of Code 39 used in the marking of computer tape cartridges. Trioptic Code 39 symbols always contain six characters.

Scan one of the following bar codes to enable or disable Trioptic Code 39.

*NOTE: You cannot enable Trioptic Code 39 and Code 39 Full ASCII simultaneously.*

Enable Trioptic Code 39



Disable Trioptic Code 39\*



### 3.3.3 Convert Code 39 to Code 32

Code 32 is a variant of Code 39 used by the Italian pharmaceutical industry. Scan one of the following bar codes to enable or disable converting Code 39 to Code 32.

*NOTE: Code 39 must be enabled for this parameter to function.*

#### Enable Convert Code 39 to Code 32



#### Disable Convert Code 39 to Code 32\*



### 3.3.4 Code 32 Prefix

Scan one of the following bar codes to enable or disable adding the prefix character "A" to all Code 32 bar codes.

*NOTE: Convert Code 39 to Code 32 must be enabled for this parameter to function.*

#### Enable Code 32 Prefix



#### Disable Code 32 Prefix\*



### 3.3.5 Set Lengths for Code 39

The length of a code refers to the number of characters (i.e., human readable characters), including check digit(s) the code contains. Set lengths for Code 39 to any length, one or two discrete lengths, or lengths within a specific range. If Code 39 Full ASCII is enabled, Length Within Range or Any Length are the preferred options. The default is Length Within Range: 2 to 55.

Scan one of the following bar codes to select a length option:

- **One Discrete Length** - Decode only Code 39 symbols containing a selected length. Select the length using the bar codes in [Appendix B, Numeric Bar Codes](#). For example, to decode only Code 39 symbols with 14 characters, scan Code 39 - One Discrete Length, and then scan 1, 4. To correct an error or change the selection, [scan Cancel](#).
- **Two Discrete Lengths** - Decode only Code 39 symbols containing either of two lengths. Select lengths using the bar codes in [Appendix B, Numeric Bar Codes](#). For example, to decode only Code 39 symbols containing either 2 or 14 characters, scan Code 39 - Two Discrete Lengths, and then scan 0, 2, 1, 4. To correct an error or change the selection, [scan Cancel](#).
- **Length Within Range** - Decode Code 39 symbols with a specific length range. Select lengths using the bar codes in [Appendix B, Numeric Bar Codes](#). For example, to decode Code 39 symbols containing between 4 and 12 characters, scan Code 39 - Length Within Range, and then scan 0, 4, 1, 2. To correct an error or change the selection, [scan Cancel](#).
- **Any Length** - Decode Code 39 symbols containing any number of characters within the engine's capability.

*NOTE : When setting lengths, enter a leading zero for single digit numbers.*

### 3.3.6 Set Lengths for Code 39

Code 39 - One Discrete Length



Code 39 - Two Discrete Lengths



Code 39 - Length Within Range(Default: 2 to 55) \*



Code 39 - Any Length



### 3.3.7 Code 39 Check Digit Verification

Scan Enable Code 39 Check Digit to check the integrity of all Code 39 symbols to verify that the data complies with specified check digit algorithm. Only Code 39 symbols which include a modulo 43 check digit are decoded. Enable this feature if the Code 39 symbols contain a Modulo 43 check digit.

Enable Code 39 Check Digit



Disable Code 39 Check Digit \*



### 3.3.8 Transmit Code 39 Check Digit

Scan one of the following bar codes to transmit Code 39 data with or without the check digit.

*NOTE: Code 39 Check Digit Verification must be enabled for this parameter to function.*

**Transmit Code 39 Check Digit (Enable)**



**Do Not Transmit Code 39 Check Digit (Disable) \***



### 3.3.9 Code 39 Full ASCII Conversion

Code 39 Full ASCII is a variant of Code 39 which pairs characters to encode the full ASCII character set. Scan one of the following bar codes to enable or disable Code 39 Full ASCII.

*NOTE: You cannot enable Trioptic Code 39 and Code 39 Full ASCII simultaneously.*

**Enable Code 39 Full ASCII**



**Disable Code 39 Full ASCII \***



### 3.3.10 Code 39 Security Level

The engine offers four levels of decode security for Code 39 bar codes. There is an inverse relationship between security and engine aggressiveness. Increasing the level of security can reduce scanning aggressiveness, so select only the level of security necessary.

- **Code 39 Security Level 0:** The engine operates in its most aggressive state, while providing sufficient security in decoding most in-spec bar codes.
- **Code 39 Security Level 1:** This default setting eliminates most misdecodes.
- **Code 39 Security Level 2:** This option applies greater bar code security requirements if Security Level 1 fails to eliminate misdecodes.
- **Code 39 Level 3:** If you selected Security Level 2, and misdecodes still occur, select this security level to apply the highest safety requirements.

*NOTE Selecting this option is an extreme measure against mis-decoding severely out-of-spec bar codes, and significantly impairs the decoding ability of the engine. If this level of security is required, try to improve the quality of the bar codes.*

### 3.3.11 Code 39 Security Level

Code 39 Security Level 0



Code 39 Security Level 1\*



Code 39 Security Level 2



Code 39 Security Level 3



### 3.3.12 Code 39 Reduced Quiet Zone

Scan one of the following bar codes to enable or disable decoding Code 39 bar codes with reduced quiet zones (the margins on either side of the bar code). If you select Enable, select a [1D Quiet Zone Level](#).

Enable Code 39 Reduced Quiet Zone



Disable Code 39 Reduced Quiet Zone\*



## 3.4 Code 93

---

Scan one of the following bar codes to enable or disable Code 93.

**Enable Code 93\***



**Disable Code 93**



### 3.4.1 Set Lengths for Code 128

The length of a code refers to the number of characters (i.e., human readable characters), including check digit(s) the code contains. Set lengths for Code 93 to any length, one or two discrete lengths, or lengths within a specific range. The default is Length Within Range: 4 to 55.

*NOTE: When setting lengths, enter a leading zero for single digit numbers.*

Scan one of the following bar codes to select a length option:

- **One Discrete Length** - Decode only Code 93 symbols containing a selected length. Select the length using the bar codes in [Appendix B, Numeric Bar Codes](#). For example, to decode only Code 93 symbols with 14 characters, scan Code 93 - One Discrete Length, and then scan 1, 4. To correct an error or change the selection, [scan Cancel](#).
- **Two Discrete Lengths** - Decode only Code 93 symbols containing either of two lengths. Select lengths using the bar codes in [Appendix B, Numeric Bar Codes](#). For example, to decode only Code 93 symbols containing either 2 or 14 characters, scan Code 93 - Two Discrete Lengths, and then scan 0, 2, 1, 4. To correct an error or change the selection, [scan Cancel](#).
- **Length Within Range** - Decode Code 93 symbols with a specific length range. Select lengths using the bar codes in [Appendix B, Numeric Bar Codes](#). For example, to decode Code 93 symbols containing between 4 and 12 characters, scan Code 93 - Length Within Range, and then scan 0, 4, 1, 2. To correct an error or change the selection, [scan Cancel](#).
- **Any Length** - Decode Code 93 symbols containing any number of characters within the engine's capability.

**Code 93 - One Discrete Length**



**Code 93 - Two Discrete Lengths**



**Code 93 - Length Within Range\***



**Code 93 - Any Length**



## 3.5 Code 11

---

Scan one of the following bar codes to enable or disable Code 93.

**Enable Code 11**



**Disable Code 11\***



### 3.5.1 Set Lengths for Code 11

The length of a code refers to the number of characters (i.e., human readable characters), including check digit(s) the code contains. Set lengths for Code 11 to any length, one or two discrete lengths, or lengths within a specific range. The default is Length Within Range: 4 to 55.

*NOTE: When setting lengths, enter a leading zero for single digit numbers.*

Scan one of the following bar codes to select a length option:

- **One Discrete Length** - Decode only Code 11 symbols containing a selected length. Select the length using the bar codes in [Appendix B, Numeric Bar Codes](#). For example, to decode only Code 11 symbols with 14 characters, scan Code 11 - One Discrete Length, and then scan 1, 4. To correct an error or change the selection, [scan Cancel](#).
- **Two Discrete Lengths** - Decode only Code 11 symbols containing either of two lengths. Select lengths using the bar codes in [Appendix B, Numeric Bar Codes](#). For example, to decode only Code 11 symbols containing either 2 or 14 characters, scan Code 11 - Two Discrete Lengths, and then scan 0, 2, 1, 4. To correct an error or change the selection, [scan Cancel](#).
- **Length Within Range** - Decode Code 11 symbols with a specific length range. Select lengths using the bar codes in [Appendix B, Numeric Bar Codes](#). For example, to decode Code 11 symbols containing between 4 and 12 characters, scan Code 11 - Length Within Range, and then scan 0, 4, 1, 2. To correct an error or change the selection, [scan Cancel](#).
- **Any Length** - Decode Code 11 symbols containing any number of characters within the engine's capability.

**Code 11 - One Discrete Length**



**Code 11 - Two Discrete Lengths**



**Code 11 - Length Within Range\***  
(Default: 4 to 55)



**Code 11 - Any Length**



### 3.5.2 Code 11 Check Digit Verification

This feature allows the engine to check the integrity of all Code 11 symbols to verify that the data complies with the specified check digit algorithm. Scan one of the following bar codes to specify the number of check digits encoded in the Code 11 symbols, or to disable this feature.

**Disable\***



**One Check Digit**



**Two Check Digits**



### 3.5.3 Transmit Code 11 Check Digits

Scan one of the following bar codes to select whether or not to transmit the Code 11 check digit(s).

**Do Not Transmit Code 11 Check Digit(s) (Disable)\***

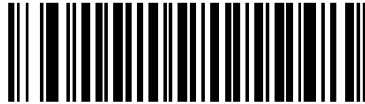

**Transmit Code 11 Check Digit(s) (Enable)**

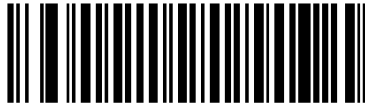

## 3.6 Interleaved 2 of 5 (ITF)

---

Scan one of the following bar codes to enable or disable Interleaved 2 of 5.

**Enable Interleaved 2 of 5**

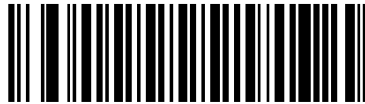

**Disable Interleaved 2 of 5\***

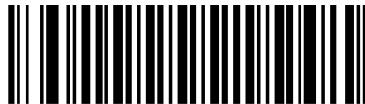

### 3.6.1 Set Lengths for Interleaved 2 of 5

The length of a code refers to the number of characters (i.e., human readable characters), including check digit(s) the code contains. Set lengths for I 2 of 5 to any length, one or two discrete lengths, or lengths within a specific range. The default is One Discrete Length: 14.

*NOTE: When setting lengths, enter a leading zero for single digit numbers.*

Scan one of the following bar codes to select a length option:

- **One Discrete Length** - Decode only I 2 of 5 symbols containing a selected length. Select the length using the bar codes in [Appendix B, Numeric Bar Codes](#). For example, to decode only I 2 of 5 symbols with 14 characters, scan I 2 of 5 - One Discrete Length, and then scan 1, 4. To correct an error or change the selection, [scan Cancel](#).
- **Two Discrete Lengths** - Decode only I 2 of 5 symbols containing either of two lengths. Select lengths using the bar codes in [Appendix B, Numeric Bar Codes](#). For example, to decode only I 2 of 5 symbols containing either 2 or 14 characters, scan I 2 of 5 - Two Discrete Lengths, and then scan 0, 2, 1, 4. To correct an error or change the selection, [scan Cancel](#).
- **Length Within Range** - Decode I 2 of 5 symbols with a specific length range. Select lengths using the bar codes in [Appendix B, Numeric Bar Codes](#). For example, to decode I 2 of 5 symbols containing between 4 and 12 characters, scan I 2 of 5 - Length Within Range, and then scan 0, 4, 1, 2. To correct an error or change the selection, [scan Cancel](#).
- **Any Length** - Decode I 2 of 5 symbols containing any number of characters within the engine's capability

*NOTE: Due to the construction of the I 2 of 5 symbology, it is possible for a scan line covering only a portion of the code to transmit as a complete scan, yielding less data than is encoded in the bar code. To prevent this, select specific lengths (I 2 of 5 - One Discrete Length, Two Discrete Lengths) for I 2 of 5 applications, or increase the I 2 of 5 Security Level.*

**I 2 of 5 - One Discrete Length\***

**(Default: 14)**



**I 2 of 5 - Length Within Range**



**I 2 of 5 - Two Discrete Lengths**



**I 2 of 5 - Any Length**



### 3.6.2 I 2 of 5 Check Digit Verification

Scan one of the following bar codes to check the integrity of all I 2 of 5 symbols to verify the data complies with either the specified Uniform Symbology Specification (USS), or the Optical Product Code Council (OPCC) check digit algorithm.

**Disable\***



**USS Check Digit**



**OPCC Check Digit**



### 3.6.3 Transmit I 2 of 5 Check Digit

Scan one of the following bar codes to transmit I 2 of 5 data with or without the check digit.

**Transmit I 2 of 5 Check Digit (Enable)**



**Do Not Transmit I 2 of 5 Check Digit (Disable)\***



### 3.6.4 Convert I 2 of 5 to EAN-13

Scan Convert I 2 of 5 to EAN-13 (Enable) to convert 14-character I 2 of 5 codes to EAN-13, and transmit to the host as EAN-13. To accomplish this, the I 2 of 5 code must be enabled, and the code must have a leading zero and a valid EAN-13 check digit.

**Convert I 2 of 5 to EAN-13 (Enable)**



**Do Not Convert I 2 of 5 to EAN-13 (Disable)\***



### 3.6.5 I 2 of 5 Security Level

Interleaved 2 of 5 bar codes are vulnerable to misdecodes, particularly when I 2 of 5 Lengths is set to Any Length. The engine offers four levels of decode security for Interleaved 2 of 5 bar codes. There is an inverse relationship between security and engine aggressiveness. Increasing the level of security can reduce scanning aggressiveness, so select only the level of security necessary.

- **I 2 of 5 Security Level 0:** The engine operates in its most aggressive state, while providing sufficient security in decoding most in-spec bar codes.
- **I 2 of 5 Security Level 1:** A bar code must be successfully read twice, and satisfy certain safety requirements before being decoded. This default setting eliminates most misdecodes.
- **I 2 of 5 Security Level 2:** This option applies greater bar code security requirements if Security Level 1 fails to eliminate misdecodes.
- **I 2 of 5 Security Level 3:** If you selected Security Level 2, and misdecodes still occur, select this security level. The highest safety requirements are applied. A bar code must be successfully read three times before being decoded.

*NOTE: Selecting this option is an extreme measure against mis-decoding severely out-of-spec bar codes, and significantly impairs the decoding ability of the engine. If this level of security is required, try to improve the quality of the bar codes.*

I 2 of 5 Security Level 0



I 2 of 5 Security Level 1\*



I 2 of 5 Security Level 2



I 2 of 5 Security Level 3



### 3.6.6 I 2 of 5 Reduced Quiet Zone

Scan one of the following bar codes to enable or disable decoding I 2 of 5 bar codes with reduced quiet zones (the margins on either side of the bar code). If you select Enable, select a [1D Quiet Zone Level](#).

**Enable I 2 of 5 Reduced Quiet Zone**



**Disable I 2 of 5 Reduced Quiet Zone\***



## 3.7 Discrete 2 of 5 (DTF)

---

Scan one of the following bar codes to enable or disable Discrete 2 of 5.

Enable Discrete 2 of 5



Disable Discrete 2 of 5\*



### 3.7.1 Set Lengths for Discrete 2 of 5

The length of a code refers to the number of characters (i.e., human readable characters), including check digit(s) the code contains. Set lengths for D 2 of 5 to any length, one or two discrete lengths, or lengths within a specific range. The default is One Discrete Length: 12.

*NOTE: When setting lengths, enter a leading zero for single digit numbers.*

Scan one of the following bar codes to select a length option:

- **One Discrete Length** - Decode only D 2 of 5 symbols containing a selected length. Select the length using the bar codes in [Appendix B, Numeric Bar Codes](#). For example, to decode only D 2 of 5 symbols with 14 characters, scan D 2 of 5 - One Discrete Length, and then scan 1, 4. To correct an error or change the selection, [scan Cancel](#).
- **Two Discrete Lengths** - Decode only D 2 of 5 symbols containing either of two lengths. Select lengths using the bar codes in [Appendix B, Numeric Bar Codes](#). For example, to decode only D 2 of 5 symbols containing either 2 or 14 characters, scan D 2 of 5 - Two Discrete Lengths, and then scan 0, 2, 1, 4. To correct an error or change the selection, [scan Cancel](#).

- **Length Within Range** - Decode D 2 of 5 symbols with a specific length range. Select lengths using the bar codes in [Appendix B, Numeric Bar Codes](#). For example, to decode D 2 of 5 symbols containing between 4 and 12 characters, scan D 2 of 5 - Length Within Range, and then scan 0, 4, 1, 2. To correct an error or change the selection, [scan Cancel](#).
- **Any Length** - Decode D 2 of 5 symbols containing any number of characters within the engine's capability.

*NOTE: Due to the construction of the D 2 of 5 symbology, it is possible for a scan line covering only a portion of the code to transmit as a complete scan, yielding less data than is encoded in the bar code. To prevent this, select specific lengths (D 2 of 5 - One Discrete Length, Two Discrete Lengths) for D 2 of 5 applications.*

**D 2 of 5 - One Discrete Length\***  
(Default: 12)



**D 2 of 5 - Two Discrete Lengths**



**D 2 of 5 - Length Within Range**



**D 2 of 5 - Any Length**



## 3.8 Codabar (NW - 7)

---

Scan one of the following bar codes to enable or disable Codabar.

Enable Codabar\*



Disable Codabar



### 3.8.1 Set Lengths for Codabar

The length of a code refers to the number of characters (i.e., human readable characters), including check digit(s) the code contains. Set lengths for Codabar to any length, one or two discrete lengths, or lengths within a specific range. The default is Length Within Range: 5 to 55.

*NOTE: When setting lengths, enter a leading zero for single digit numbers.*

Scan one of the following bar codes to select a length option:

- **One Discrete Length** - Decode only Codabar symbols containing a selected length. Select the length using the bar codes in [Appendix B, Numeric Bar Codes](#). For example, to decode only Codabar symbols with 14 characters, scan Codabar - One Discrete Length, and then scan 1, 4. To correct an error or change the selection, [scan Cancel](#).
- **Two Discrete Lengths** - Decode only Codabar symbols containing either of two lengths. Select lengths using the bar codes in [Appendix B, Numeric Bar Codes](#). For example, to decode only Codabar symbols containing either 2 or 14 characters, scan Codabar - Two Discrete Lengths, and then scan 0, 2, 1, 4. To correct an error or change the

selection, [scan Cancel](#).

- **Length Within Range** - Decode Codabar symbols with a specific length range. Select lengths using the bar codes in [Appendix B, Numeric Bar Codes](#). For example, to decode Codabar symbols containing between 4 and 12 characters, scan Codabar - Length Within Range, and then scan 0, 4, 1, 2. To correct an error or change the selection, [scan Cancel](#).
- **Any Length** - Decode Codabar symbols containing any number of characters within the engine's capability.

**Codabar - One Discrete Length**



**Codabar - Two Discrete Lengths**



**Codabar - Length Within Range\***  
(Default: 5 to 55)



**Codabar - Any Length**



### 3.8.2 CLSI Editing

Scan **Enable CLSI Editing** to strip the start and stop characters and insert a space after the first, fifth, and tenth characters of a 14-character Codabar symbol if the host system requires this data format.

*NOTE: Symbol length does not include start and stop characters.*

#### Enable CLSI Editing

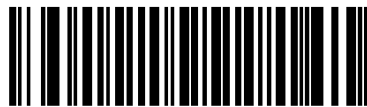

#### Disable CLSI Editing\*



### 3.8.3 NOTIS Editing

Scan **Enable NOTIS Editing** to strip the start and stop characters from a decoded Codabar symbol if the host system requires this data format.

#### Enable NOTIS Editing



#### Disable NOTIS Editing\*



## 3.8.4 Codabar Upper or Lower Case Start/Stop Characters

Scan one of the following bar codes to select whether to transmit upper case or lower case Codabar start/stop characters.

Lower Case



Upper Case\*



## 3.9 MSI

---

Scan one of the following bar codes to enable or disable MSI.

Enable MSI



Disable MSI \*



### 3.9.1 Set Lengths for MSI

The length of a code refers to the number of characters (i.e., human readable characters), including check digit(s) the code contains. Set lengths for MSI to any length, one or two discrete lengths, or lengths within a specific range. The default is Length Within Range: 4 to 55.

*NOTE: When setting lengths, enter a leading zero for single digit numbers.*

Scan one of the following bar codes to select a length option:

- **One Discrete Length** - Decode only MSI symbols containing a selected length. Select the length using the bar codes in [Appendix B, Numeric Bar Codes](#). For example, to decode only MSI symbols with 14 characters, scan MSI - One Discrete Length, and then scan 1, 4. To correct an error or change the selection, [scan Cancel](#).
- **Two Discrete Lengths** - Decode only MSI symbols containing either of two lengths. Select lengths using the bar codes in [Appendix B, Numeric Bar Codes](#). For example, to decode only MSI symbols containing either 2 or 14 characters, scan MSI - Two Discrete Lengths, and then scan 0, 2, 1, 4. To correct an error or change the selection, [scan Cancel](#).

- **Length Within Range** - Decode MSI symbols with a specific length range. Select lengths using the bar codes in [Appendix B, Numeric Bar Codes](#). For example, to decode MSI symbols containing between 4 and 12 characters, scan MSI - Length Within Range, and then scan 0, 4, 1, 2. To correct an error or change the selection, [scan Cancel](#).
- **Any Length** - Decode MSI symbols containing any number of characters within the engine's capability.

*NOTE: Due to the construction of the MSI symbology, it is possible for a scan line covering only a portion of the code to transmit as a complete scan, yielding less data than is encoded in the bar code. To prevent this, select specific lengths (MSI - One Discrete Length, Two Discrete Lengths) for MSI applications.*

**MSI - One Discrete Length**



**MSI - Two Discrete Lengths**



**MSI - Length Within Range\***

(Default: 4 to 55)



**MSI - Any Length**



### 3.9.2 MSI Check Digits

With MSI symbols, one check digit is mandatory and always verified by the reader. The second check digit is optional. If the MSI codes include two check digits, scan the Two MSI Check Digits bar code to enable verification of the second check digit. See [MSI Check Digit Algorithm](#) to select second digit algorithms.

**One MSI Check Digit \***



**Two MSI Check Digits**



### 3.9.3 Transmit MSI Check Digit(s)

Scan one of the following bar codes to transmit MSI data with or without the check digit.

**Transmit MSI Check Digit(s) (Enable)**



**Do Not Transmit MSI Check Digit(s) (Disable)\***



### 3.9.4 Transmit MSI Check Digit(s)

Scan one of the following bar codes to transmit MSI data with or without the check digit.

**Transmit MSI Check Digit(s) (Enable)**



**Do Not Transmit MSI Check Digit(s) (Disable)\***



### 3.9.5 MSI Check Digit Algorithm

Two algorithms are available for verifying the second MSI check digit. Scan one of the following bar codes to select the algorithm used to encode the check digit.

**MOD 11/MOD 10**

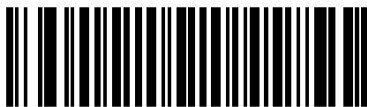

**MOD 10/MOD 10\***

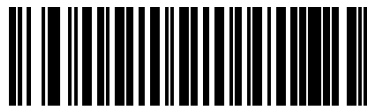

### 3.9.6 MSI Reduced Quiet Zone

Scan one of the following bar codes to enable or disable decoding MSI bar codes with reduced quiet zones. If you select Enable, select a [1D Quiet Zone Level](#).

**Disable MSI Reduced Quiet Zone\***



**Enable MSI Reduced Quiet Zone**



## 3.10 Chinese 2 of 5

---

Scan one of the following bar codes to enable or disable Chinese 2 of 5.

Enable Chinese 2 of 5



Disable Chinese 2 of 5\*



## 3.11 Matrix 2 of 5

---

Scan one of the following bar codes to enable or disable Matrix 2 of 5.

Enable Matrix 2 of 5



Disable Matrix 2 of 5\*



### 3.11.1 Set Lengths for Matrix 2 of 5

The length of a code refers to the number of characters (i.e., human readable characters), including check digit(s) the code contains. Set lengths for Matrix 2 of 5 to any length, one or two discrete lengths, or lengths within a specific range. The default is One Discrete Length: 14.

*NOTE: When setting lengths, enter a leading zero for single digit numbers.*

Scan one of the following bar codes to select a length option:

- **One Discrete Length** - Decode only Matrix 2 of 5 symbols containing a selected length. Select the length using the bar codes in [Appendix B, Numeric Bar Codes](#). For example, to decode only Matrix 2 of 5 symbols with 14 characters, scan Matrix 2 of 5 - One Discrete Length, and then scan 1, 4. To correct an error or change the selection, [scan Cancel](#).
- **Two Discrete Lengths** - Decode only Matrix 2 of 5 symbols containing either of two lengths. Select lengths using the bar codes in [Appendix B, Numeric Bar Codes](#). For example, to decode only Matrix 2 of 5 symbols containing either 2 or 14 characters, scan Matrix 2 of 5 - Two Discrete Lengths, and then scan 0, 2, 1, 4. To correct an error or change the selection, [scan Cancel](#).
- **Length Within Range** - Decode Matrix 2 of 5 symbols with a specific length range. Select lengths using the bar codes in [Appendix B, Numeric Bar Codes](#). For example, to decode Matrix 2 of 5 symbols containing between 4 and 12 characters, scan Matrix 2 of 5 - Length Within Range, and then scan 0, 4, 1, 2. To correct an error or change the selection, [scan Cancel](#).
- **Any Length** - Decode Matrix 2 of 5 symbols containing any number of characters within the engine's capability.

**Matrix 2 of 5 - One Discrete Length\***

(Default: 14)



**Matrix 2 of 5 - Two Discrete Lengths**



**Matrix 2 of 5 - Length Within Range**



**Matrix 2 of 5 - Any Length**



### 3.11.2 Matrix 2 of 5 Check Digit

The check digit is the last character of the symbol used to verify the integrity of the data. Scan one of the following bar codes to determine whether to include the Matrix 2 of 5 check digit with the bar code data.

**Enable Matrix 2 of 5 Check Digit**



**Disable Matrix 2 of 5 Check Digit\***



### 3.11.3 Transmit Matrix 2 of 5 Check Digit

Scan one of the following bar codes to transmit Matrix 2 of 5 data with or without the check digit.

**Transmit Matrix 2 of 5 Check Digit**



**Do Not Transmit Matrix 2 of 5 Check Digit\***



## 3.12 Inverse 1D

---

Scan one of the following bar codes to set the 1D inverse decoder setting:

- Regular Only** - The engine decodes regular 1D bar codes only
- Inverse Only** - The engine decodes inverse 1D bar codes only
- Inverse Autodetect** - The engine decodes both regular and inverse 1D barcodes.

*NOTE: This parameter does not apply to GS1 DataBar code types*

*The Inverse 1D setting may impact Composite or Inverse Composite decoding. See Composite Inverse.*

**Regular\***



**Inverse Only**



**Inverse Autodetect**



## 3.13 GS1 DataBar

---

The variants of GS1 DataBar are DataBar-14, DataBar Expanded, and DataBar Limited. The limited and expanded versions have stacked variants. Scan the appropriate bar codes to enable or disable each variant of GS1 DataBar.

### 3.13.1 GS1 DataBar-14

Enable GS1 DataBar-14\*



Disable GS1 DataBar-14



### 3.13.2 GS1 DataBar Limited

Enable GS1 DataBar Limited\*



Disable GS1 DataBar Limited



### 3.13.3 GS1 DataBar Expanded

**Enable GS1 DataBar Expanded\***



**Disable GS1 DataBar Expanded**



### 3.13.4 Convert GS1 DataBar to UPC/EAN/JAN

This parameter only applies to GS1 DataBar-14 and GS1 DataBar Limited symbols not decoded as part of a Composite symbol. Scan Enable Convert GS1 DataBar to UPC/EAN/JAN to strip the leading '010' from DataBar-14 and DataBar Limited symbols encoding a single zero as the first digit, and report the bar code as EAN-13.

For bar codes beginning with between two and five zeros, this strips the leading '0100' and reports the bar code as UPC-A. The UPC-A Preamble option that transmits the system character and country code applies to converted bar codes. Note that neither the system character nor the check digit can be stripped.

**Enable Convert GS1 DataBar to UPC/EAN/JAN**



**Disable Convert GS1 DataBar to UPC/EAN/JAN\***



### 3.13.5 GS1 DataBar Security Level

The engine offers four levels of decode security for GS1 DataBar (GS1 DataBar-14, GS1 DataBar Limited, GS1 DataBar Expanded) bar codes.

- **Security Level 0** - The engine operates in its most aggressive state, while providing sufficient security decoding most in-spec bar codes.
- **Security Level 1** - This setting eliminates most misdecodes while maintaining reasonable aggressiveness.
- **Security Level 2** - Select this option with greater bar code security requirements if Security Level 1 fails to eliminate misdecodes
- **Security Level 3** - If you selected Security Level 2 and misdecodes still occur, select this security level to apply the highest safety requirements.

**GS1 DataBar Security Level 0**



**GS1 DataBar Security Level 1\***



**GS1 DataBar Security Level 2**



**GS1 DataBar Security Level 3**



### 3.13.6 GS1 DataBar Limited Margin Check

The engine offers four levels of decode security for GS1 DataBar Limited bar codes. There is an inverse relationship between the level of margin check and engine aggressiveness. Increasing the level of margin check can reduce scanning aggressiveness, so select only the level of margin check necessary.

- **Margin Check Level 1** – No clear margin required. This complies with the original GS1 standard, yet can result in erroneous decoding of a DataBar Limited bar code when scanning some UPC symbols that start with digits 9 and 7.
- **Margin Check Level 2** – Automatic risk detection. This level of margin check can result in erroneous decoding of DataBar Limited bar codes when scanning some UPC symbols. If a misdecode is detected, the engine operates in Level 3 or Level 1.
- **Margin Check Level 3** – Margin check level reflects the newly proposed GS1 standard that requires a five times trailing clear margin.
- **Margin Check Level 4** – Security level extends beyond the standard required by GS1. This level of margin check requires a five times leading and trailing clear margin.

**GS1 DataBar Limited Margin Check Level 1**



**GS1 DataBar Limited Margin Check Level 2**



**GS1 DataBar Limited Margin Check Level 3\***



**GS1 DataBar Limited Margin Check Level 4**



### 3.13.7 GS1 DataBar Expanded Security Level

The engine offers four levels of decode security for GS1 DataBar Expanded bar codes.

- **Security Level 0** - The engine operates in its most aggressive state, while providing sufficient security decoding most in-spec bar codes.
- **Security Level 1** - This setting eliminates most misdecodes while maintaining reasonable aggressiveness.
- **Security Level 2** - Select this option with greater bar code security requirements if Security Level 1 fails to eliminate misdecodes.
- **Security Level 3** - If you selected Security Level 2 and misdecodes still occur, select this security level to apply the highest safety requirements.

#### GS1 DataBar Expanded Security Level 0



#### GS1 DataBar Expanded Security Level 1\*



#### GS1 DataBar Expanded Security Level 2



#### GS1 DataBar Expanded Security Level 3



## 3.14 Symbology-Specific Security Features

---

### 3.14.1 Redundancy Level

The engine offers four levels of decode redundancy. Select higher redundancy levels for decreasing levels of bar code quality.

As redundancy levels increase, the engine's aggressiveness decreases.

Scan one of the following bar codes to select the redundancy level appropriate for the bar code quality:

- **Redundancy Level 1** - The engine must read the following code types twice before decoding:
  - ◆ Codabar (8 characters or less)
  - ◆ MSI (4 characters or less)
  - ◆ D 2 of 5 (8 characters or less)
  - ◆ I 2 of 5 (8 characters or less)
- **Redundancy Level 2** - The engine must read all code types twice before decoding.
- **Redundancy Level 3** - The engine must read code types other than the following twice before decoding, but must read the following codes three times:
  - ◆ Codabar (8 characters or less)
  - ◆ MSI (4 characters or less)
  - ◆ D 2 of 5 (8 characters or less)
  - ◆ I 2 of 5 (8 characters or less)
- **Redundancy Level 4** - The engine must read all code types three times before decoding.

**Redundancy Level 1\***



**Redundancy Level 2**



**Redundancy Level 3**



**Redundancy Level 4**



### 3.14.2 Security Level

The engine offers four levels of decode security for delta bar codes, which include the Code 128 family, UPC/EAN/JAN, and Code 93. Select increasing levels of security for decreasing levels of bar code quality. There is an inverse relationship between security and engine aggressiveness, so choose only that level of security necessary for the application.

- Security Level 0** - The engine operates in its most aggressive state, while providing sufficient security decoding most in-spec bar codes.
- Security Level 1** - This default setting eliminates most misdecodes.
- Security Level 2** - Select this option if Security Level 1 fails to eliminate misdecodes
- Security Level 3** - If you selected Security Level 2 and misdecodes still occur, select this security level.

*NOTE: Selecting this option is an extreme measure against mis-decoding severely out-of-spec bar codes, and significantly impairs the decoding ability of the engine. If this level of security is required, try to improve the quality of the bar codes.*

#### Security Level 0



#### Security Level 1\*



#### Security Level 2



#### Security Level 3



### 3.14.3 1D Quiet Zone Level

This feature sets the level of aggressiveness when decoding bar codes with a reduced quiet zone (the margin on either side of a bar code), and applies to symbologies enabled by a Reduced Quiet Zone parameter. Because higher levels increase the decoding time and risk of misdecodes, Zebra strongly recommends enabling only the symbologies which require higher quiet zone levels, and leaving Reduced Quiet Zone disabled for all other symbologies. Options are:

- **1D Quiet Zone Level 0** - The engine performs normally in terms of quiet zone.
- **1D Quiet Zone Level 1** - The engine performs more aggressively in terms of quiet zone.
- **1D Quiet Zone Level 2** - The engine only requires a quiet zone at the end of bar code for decoding.
- **1D Quiet Zone Level 3** - The engine decodes anything in terms of quiet zone or end of bar code.

**1D Quiet Zone Level 0**



**1D Quiet Zone Level 1\***



**1D Quiet Zone Level 2**



**1D Quiet Zone Level 3**



### 3.14.4 Intercharacter Gap Size

The Code 39 and Codabar symbologies have an intercharacter gap that is typically quite small. Due to various bar code printing technologies, this gap can grow larger than the maximum size allowed, preventing the engine from decoding the symbol. If this problem occurs, scan the **Large Intercharacter Gaps** parameter to tolerate these out-of-specification bar codes.

#### Normal Intercharacter Gaps\*



#### Large Intercharacter Gaps



## 3.15 Composite

---

### 3.15.1 Composite CC-C

Scan one of the following bar codes to enable or disable Composite bar codes of type CC-C.

**Enable CC-C**

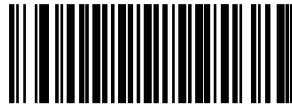

**Disable CC-C\***



### 3.15.2 Composite CC-A/B

Scan one of the following bar codes to enable or disable Composite bar codes of type CC-A/B.

**Enable CC-A/B**



**Disable CC-A/B\***

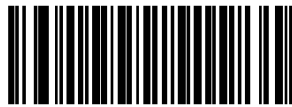

### 3.15.3 Composite TLC-39

Scan one of the following bar codes to enable or disable Composite bar codes of type TLC-39.

Enable TLC39



Disable TLC39\*



### 3.15.4 Composite Inverse

Select an option to set Composite for either regular decode or inverse decode.

- **Regular Only** - The engine decodes regular Composite bar codes only. Before selecting this, set Inverse 1D to Regular Only or Inverse Autodetect.
- **Inverse Only** - The engine decodes inverse Composite bar codes only. This mode only supports Composite Inverse that includes DataBar combined with CCAB, and does not support other 1D/2D combinations. Before selecting this, first enable Composite CC-A/B , and set Inverse 1D to Inverse Only or Inverse Autodetect.

Regular Only\*



Inverse Only



### 3.15.5 UPC Composite Mode

Select an option for linking UPC symbols with a 2D symbol during transmission as if they were one symbol:

- **UPC Never Linked** –  
Transmit UPC bar codes regardless of whether a 2D symbol is detected.
- **UPC Always Linked** –  
Transmit UPC bar codes and the 2D portion. If 2D is not present, do not transmit the bar code
- **Autodiscriminate UPC Composites** –  
The engine determines if there is a 2D portion, then transmits the UPC, as well as the 2D portion if present.

**UPC Never Linked\***



**UPC Always Linked**

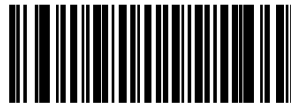

**Autodiscriminate UPC Composites**

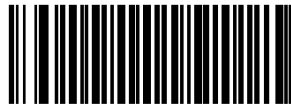

## 3.16 2D Symbologies

---

### 3.16.1 PDF417

Scan one of the following bar codes to enable or disable PDF417.

**Enable PDF417\***



**Disable PDF417**



### 3.16.2 MicroPDF417

Scan one of the following bar codes to enable or disable MicroPDF417.

**Enable MicroPDF417**



**Disable MicroPDF417 \***



### 3.16.3 Code 128 Emulation

Enable this parameter to transmit data from certain MicroPDF417 symbols as Code 128. You must enable AIM Code ID Character (1) for this parameter to work.

Enable Code 128 Emulation to transmit these MicroPDF417 symbols with one of the following prefixes:

JC1 if the first codeword is 903-905

JC2 if the first codeword is 908 or 909

JC0 if the first codeword is 910 or 911

Disable Code 128 Emulation to transmit these MicroPDF417 symbols with one of the following prefixes:

JL3 if the first codeword is 903-905

JL4 if the first codeword is 908 or 909

JL5 if the first codeword is 910 or 911

Scan one of the following bar codes to enable or disable Code 128 Emulation.

*NOTE: Linked MicroPDF codewords 906, 907, 912, 914, and 915 are not supported. Use GS1 Composites instead.*

#### Enable Code 128 Emulation



#### Disable Code 128 Emulation \*



### 3.16.4 Data Matrix

Scan one of the following bar codes to enable or disable Data Matrix.

**Enable Data Matrix\***



**Disable Data Matrix**



### 3.16.5 Data Matrix Inverse

Scan one of the following bar codes to select the Data Matrix inverse decoder setting:

- **Regular Only** - The engine decodes regular Data Matrix bar codes only.
- **Inverse Only** - The engine decodes inverse Data Matrix bar codes only.
- **Inverse Autodetect** - The engine decodes both regular and inverse Data Matrix bar codes.

**Regular Only**



**Inverse Only**



**Inverse Autodetect\***



### 3.16.6 Decode Data Matrix Mirror Images

Scan one of the following bar codes to select an option for decoding mirror image Data Matrix bar codes:

- **Never** - Do not decode Data Matrix bar codes that are mirror images.
- **Always** - Decode only Data Matrix bar codes that are mirror images.
- **Auto** - Decode both mirrored and unmirrored Data Matrix bar codes.

**Never**



**Always**



**Auto\***



### 3.16.7 Maxicode

Scan one of the following bar codes to enable or disable Maxicode.

**Enable Maxicode**



**Disable Maxicode\***



### 3.16.8 QR Code

Scan one of the following bar codes to enable or disable QR Code.

*NOTE: Enabling this also enables QR Inverse, QR Mirrored, and Linked QR.*

**Enable QR Code\***



**Disable QR Code**



### 3.16.9 Aztec

Scan one of the following bar codes to enable or disable Aztec.

*NOTE: Enabling this also enables Linked Aztec.*

**Enable Aztec \***



**Disable Aztec**



### 3.16.10 Aztec Inverse

Scan one of the following bar codes to select the Aztec inverse decoder setting:

- Regular Only** - The engine decodes regular Aztec bar codes only.
- Inverse Only** - The engine decodes inverse Aztec bar codes only.
- Inverse Autodetect** - The engine decodes both regular and inverse Aztec bar codes.

**Regular Only**



**Inverse Only**



**Inverse Autodetect \***



### 3.16.11 Han Xin

Scan one of the following bar codes to enable or disable Han Xin.

**Enable Han Xin**



**Disable Han Xin \***



### 3.16.12 Han Xin Inverse

Scan one of the following bar codes to select a Han Xin inverse decoder setting:

- **Regular Only** - The engine decodes Han Xin bar codes with normal reflectance only.
- **Inverse Only** - The engine decodes Han Xin bar codes with inverse reflectance only.
- **Inverse Autodetect** - The engine decodes both regular and inverse Han Xin bar codes.

**Regular Only\***



**Inverse Only**



**Inverse Autodetect**



## 3.17 Macro PDF Features

---

Macro PDF is a special feature for concatenating multiple PDF symbols into one file. The engine can decode symbols encoded with this feature, and can store more than 64 Kb of decoded data from up to 50 MacroPDF symbols.

*CAUTION! When printing, keep each Macro PDF sequence separate, as each sequence has unique identifiers. Do not mix bar codes from several Macro PDF sequences, even if they encode the same data. When scanning a Macro PDF sequence, scan the entire sequence without interruption. When scanning a mixed sequence, two long low beeps (low / low) indicate an inconsistent file ID or inconsistent symbology error.*

### 3.17.1 Flush Macro Buffer

Scan the following bar code to flush the buffer of all decoded Macro PDF data stored to that point, transmit it to the host device, and abort from Macro PDF mode.

**Flush Macro PDF Buffer**



### 3.17.2 Flush Macro Buffer

Scan the following bar code to clear all currently-stored Macro PDF data in the buffer without transmission and abort from Macro PDF mode.

**Abort Macro PDF Entry**



### 3.17.3 Postal Codes

Scan one of the following bar codes to enable or disable US Postnet.

**Enable US Postnet**



**Disable US Postnet\***



### 3.17.4 US Planet

Scan one of the following bar codes to enable or disable US Planet.

**Enable US Planet**



**Disable US Planet\***



### 3.17.5 Transmit US Postal Check Digit

Scan one of the following bar codes to select whether to transmit US Postal data, which includes both US Postnet and US Planet, with or without the check digit.

**Enable US Planet Transmit US Postal Check Digit\***



**Do Not Transmit US Postal Check Digit**



### 3.17.6 UK Postal

Scan one of the following bar codes to enable or disable UK Postal.

**Enable UK Postal**



**Disable UK Postal\***



### 3.17.7 Transmit UK Postal Check Digit

Scan one of the following bar codes to select whether to transmit UK Postal data with or without the check digit.

**Transmit UK PostalCheck Digit\***



**Do Not Transmit UK Postal Check Digit**



### 3.17.8 Japan Postal

Scan one of the following bar codes to enable or disable Japan Postal.

**Enable Japan Postal**



**Disable Japan Postal \***



### 3.17.9 Australia Post

Scan one of the following bar codes to enable or disable Australia Post.

**Enable Australia Post**



**Disable Australia Post\***



### 3.17.10 Australia Post Format

Scan one of the following bar codes to select a format for Australia Post:

**Autodiscriminate (or Smart mode)** - Decode the Customer Information Field using the N and C Encoding Tables.

*NOTE : This option increases the risk of misdecodes because the encoded data format does not specify the Encoding Table used for encoding.*

- **Raw Format** - Output raw bar patterns as a series of numbers 0 through 3.
- **Alphanumeric Encoding** - Decode the Customer Information Field using the C Encoding Table.
- **Numeric Encoding** - Decode the Customer Information Field using the N Encoding Table.

**Autodiscriminate\***



**Raw Format**



**Alphanumeric Encoding**



**Numeric Encoding**



### 3.17.11 Netherlands KIX Code

Scan one of the following bar codes to enable or disable Netherlands KIX Code.

**Enable Netherlands KIX Code**



**Disable Netherlands KIX Code\***



### 3.17.12 UPU FICS Postal

Scan one of the following bar codes to enable or disable UPU FICS Postal.

**Enable UPU FICS Postal**



**Disable UPU FICS Postal\***



## 3.18 Set Bar Codes Enable/Disable

---

Scan below bar code to enable / disable bar code setting.

Enable\*



Disable



## **Chapter 4 – Command Settings**

### **4.1 General setting**

---

#### **4.1.1 Default**

Scan below bar code to restore the factory setting.

Factory Default



#### **4.1.2 Connect USB Drive**

Scan below bar code to connect USB drive.

*NOTE : USB drive can also be connected by double click scan button with USB cable connected to host.*

Connect USB Drive



#### **4.1.3 Display F/W Version**

Scan below bar code to display F/W version.

Display F/W Version



## 4.1.4 Auto Power Off After Idle

Scan below bar code to set up auto power off.

5 Minutes



15 Minutes\*



30 Minutes



1 Hour



2 Hours



4 Hours



6 Hours



Disable



## 4.1.5 System Config

Scan below bar code for user to export/ import their customized settings. For example, when user scan **Export As User Setting 1**, the current setting will be saved. When user scan **Import User Setting 1**, it will reload the customized settings 1 back to MS652Plus from USB drive.

Please be aware of User Setting Default will be overwritten once you scan 4.1.1 Factory Default.

Export As User Setting 1



Import User Setting 1



Export As User Setting 2



Import User Setting 2



## 4.2 Output Data Transmit

---

### 4.2.1 Auto mode

In this mode, when scanner is out off BT transmit range, the scanned data will be stored in the memory and transmit data automatically when back to in-range.

Auto mode\*



### 4.2.2 Wedge mode

In this mode, the data only transmit while the BT is connected

Wedge mode



### 4.2.3 Batch mode

In this mode, the scanned data will be stored in the memory all the time and transmit data only when BT is connected by scanned the “send batch” bar code

Batch mode



## 4.2.4 Send Batch

Scan below bar code to send the stored data to host.

Send Batch



## 4.2.5 End of Batch Sending Message

Scan below bar code to set up end of batch sending message.

If 'Send' is selected, MS652Plus will send message "# End of File  
Total=Number CS=0xHHHH #"

before the end of batch file sending.  
Number is total entries in decimal format and 0xHHHH is 32-bit checksum  
in hex format.

Send



Don't Send\*



## 4.2.6 Data & Memory

Scan below bar code to set up data & memory.

To erase buffer, scan 'Enter Auto Buffer Erase' and then scan 'Erase'.

To erase batch file , scan 'Enter Batch File' and then scan 'Erase'.



## 4.2.7 Keep Buffer Data When Power Off

Scan below bar code to keep buffer data when power off.



## 4.2.8 Control Character in Barcode

Scan below bar code to send / don't send non printable characters to the host.



## 4.3 Beep Tone, Terminator

---

### 4.3.1 Beep Tone

Scan below bar code to set up beep tone.

Beep High



Beep Low



Beep Medium\*



Mute



## 4.3.2 Data Terminator

Scan below bar code to set up terminator. (For BT SPP SCAN MODE Only)

None/Null



CR\*



CRLF



LF



TAB



## 4.4 Indicators

---

### 4.4.1 Vibrator Control

Vibrator can be disabled individually by scanning “Disable Vibrator” setting barcode as shown below.

Once vibrator is disabled and the following setting barcodes from 4.4.2-4.4.7 won't activate vibration until you scan “Enable Vibrator” setting barcode.

Enable Vibrator \*



Disable Vibrator



## 4.4.2 Good Read Indicator

For MS652Plus indicator settings, please noted that default beeper is medium and default vibrator setting is disabled. (For BT SPP SCAN MODE Only)

Good Read indicator default setting is medium beeper and disabled vibrator.

Scan below bar code to set up good read indicator.

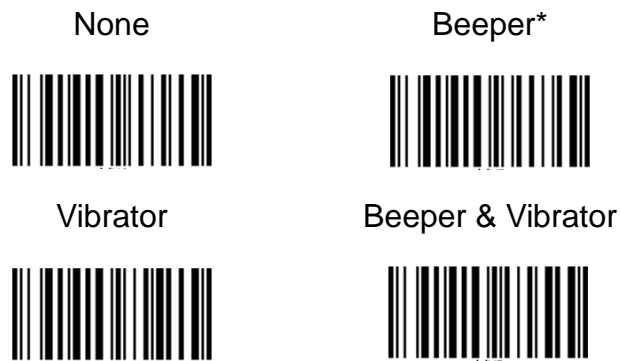

## 4.4.3 Connection Indicator

Scan below bar code to set up connection indicator.

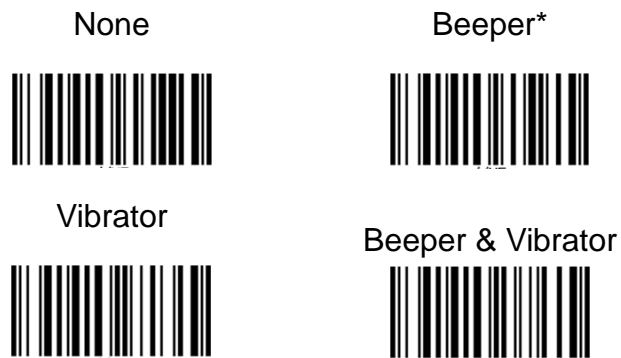

### 4.4.4 System Indicator

Scan below bar code to set up system indicator.

None



Beeper\*



Vibrator



Beeper & Vibrator



### 4.4.5 System Warning/Error Indicator

Scan below bar code to set up system warning/ error indicator.

None



Beeper\*



Vibrator



Beeper & Vibrator



### 4.4.6 Power On Indicator

Scan below bar code to set up power on indicator.

None



Beeper\*



Vibrator



Beeper & Vibrator



### 4.4.7 Power Off Alarm & Power Off Indicator

Scan below bar code to set up power off alarm & power off indicator.

None



Beeper\*



Vibrator



Beeper & Vibrator



## 4.5 HID Keyboard Config

---

### 4.5.1 Data Sending InterBlock Delay

Scan below bar code to set up power off alarm & power off indicator.

10ms\*



50ms



100ms



500ms



1 Sec.



3 Sec.



## 4.5.2 HID keyboard inter-character delay

In BT HID mode, scan below bar code to set inter-character delay time. Default is 1ms.



## 4.5.3 HID keyboard Case

In BT HID mode, scan below bar code to change the alphabet case. Scan "to lower" barcode to output data in lower case; or scan "to upper" barcode to output data in upper case. Default setting: "auto trace" to have original scanned data transmitted.



## 4.5.4 HID keyboard language

In BT HID mode, scan below bar code to change keyboard language.  
Default is US English

US English \*

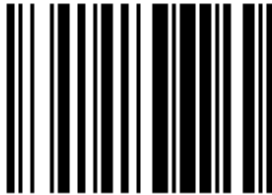

UK English



Swiss



Swedish



Norwegian



Italian



German



French



Danish



ALT Mode



Japanese (OADG109)



Spanish



Belgian



## 4.6 BT Config

---

### 4.6.1 Bluetooth® type

MS652Plus support Bluetooth® 4.2 dual mode(BLE & classic)

BT classic HID



BT classic SPP



BT BLE \*



## 4.6.2 Bluetooth® Config

Scan below bar code to set up Bluetooth® config.

1. If MS652Plus is connected to a host, un-pair will not work.  
Please remove pairing or turn bluetooth® off from the host side first & try again.
2. If there is trouble to remove pairing on host device, turn off MS652Plus & try again. After pairing on host is removed, scan 'BT/BLE Un-Pair/Pair' for new pairing.
3. If 'Higher Level RF Signal Checking' is selected, BT communication will become more reliable but the distance will be shorter.

BT/BLE Un-Pair / Pair



Normal Level RF  
Signal Checking \*



Higher Level RF Signal  
Checking



## 4.7 Procedure to Update MS652Plus Firmware via USB Drive

---

1. Connect MS652Plus as USB drive to host and double click trigger key
2. Copy firmware file 'MS652Plus\_FW\_\*.bin' to USB drive
3. Eject/Disconnect USB drive from host
4. MS652Plus will auto power off if firmware file is detected
5. Press & hold scan button for 5 seconds to power on & reboot MS652Plus

## 4.8 Procedure to Update MS652Plus Firmware via Bootloader

---

1. Download and install freeware Tera Term on Windows PC
2. Power off MS652Plus and remove battery
3. Power on MS652Plus with USB cable connected to Windows PC
4. Run Tera Term and connect to MS652Plus via CDC USB port
5. Select 'File' -> 'Transfer' -> 'YMODEM' -> 'Send' to upload firmware file 'MS652Plus\_FW\_\*.bin'
6. After firmware is received, MS652Plus will auto power off
7. Put battery back into MS652Plus
8. Power on to reboot MS652Plus

## 4.9 Trigger Mode

---

Scan one of the following bar codes to select a trigger mode for the engine:

- **Standard (Level)** - A trigger press activates decode processing. Decode processing continues until the bar code decodes, you release the trigger.
- **Presentation (Blink)** - The engine activates decode processing when it detects a bar code in its field of view. After a period of non-use, the LEDs turn off until the engine senses motion.
- **Auto Aim** - The engine projects the aiming pattern when it senses motion. A trigger press activates decode processing. After two seconds of inactivity the aiming pattern shuts off.
- **Auto Aim with Illumination** - The engine turns on the aiming pattern and internal illumination LEDs when it senses motion. A trigger press activates decode processing. After two seconds of inactivity the aiming pattern and internal illumination LEDs automatically shut off.

**Standard (Level)\***



**Presentation (Blink)**



**Auto Aim**



**Auto Aim with Illumination**



## 4.10 Picklist Mode

---

Scan one of the following bar codes to select a **Picklist Mode**, which allows you to pick and decode a bar code from multiple bar codes printed close together.

*NOTE: Enabling Picklist Mode overrides the Disable Decode Aiming Pattern options. You can not disable the decode aiming pattern when Picklist Mode is enabled.*

- **Enable Picklist Mode Always** - Picklist Mode is always enabled.
- **Disable Picklist Mode Always** - Picklist Mode is always disabled.

**Enable Picklist Mode Always**



**Disable Picklist Mode Always\***



## 4.11 Continuous Bar Code Read

---

Scan **Enable Continuous Bar Code Read** to report every bar code while the trigger is pressed.

*NOTE: We strongly recommend enabling Picklist Mode. Disabling Picklist Mode can cause accidental decodes when more than one bar code is in the engine's field of view.*

**Enable Continuous Bar Code Read**



**Disable Continuous Bar Code Read \***



## 4.12 Unique Bar Code Reporting

---

Scan **Enable Continuous Bar Code Read Uniqueness** to report only unique bar codes while the trigger is pressed. This option only applies when Continuous Bar Code Read is enabled.

**Enable Unique Bar Code Reporting**



**Disable Unique Bar Code Reporting \***



## 4.13 Mirrored Image

---

Scan **Enable Mirrored Images** to scan images in reverse, or mirrored, as if seen through a mirror. This mode is useful in applications requiring scanning through a mirror and using symbologies that do not decode in reverse. Enabling this mode when using snapshot, video, or video viewfinder mode transmits images as mirrored images.

**Disable Mirrored Image\***



**Enable Mirrored Image**



## 4.14 Decode Session Timeout

---

This parameter sets the maximum time decode processing continues during a scan attempt. It is programmable in 0.1 second increments from 0.5 to 4.9 seconds. To set a Decode Session Timeout, scan the following bar code, and then scan two bar codes from [Appendix B, Numeric Bar Codes](#) that correspond to the desired on time. Enter a leading zero for single digit numbers. For example, to set a Decode Session Timeout of 0.5 seconds, scan this bar code, and then scan the 0 and 5 bar codes. To correct an error or change the selection, [scan Cancel](#).

### Decode Session Timeout



## 4.15 Timeout Between Decodes, Same Symbol

---

Use this option in presentation mode or Continuous Bar Code Read mode to prevent the engine from continuously decoding the same bar code when it is left in the engine's field of view. The bar code must be out of the field of view for the timeout period before the engine reads the same consecutive symbol. It is programmable in 0.1 second increments from 0.0 to 9.9 seconds. The default interval is 0.6 seconds. To select the timeout between decodes for the same symbol, scan the following bar code, and then scan two bar codes from [Appendix B, Numeric Bar Codes](#) that correspond to the desired interval, in 0.1 second increments.

### Timeout Between Decodes, Same Symbol



## 4.16 Timeout Between Decodes, Different Symbols

---

Use this option in presentation mode or Continuous Bar Code Read to control the time the engine waits before decoding a different symbol. It is programmable in 0.1 second increments from 0.1 to 9.9 seconds. The default is 0.1 seconds. To select the timeout between decodes for different symbols, scan the following bar code, and then scan two bar codes from [Appendix B, Numeric Bar Codes](#) that correspond to the desired interval, in 0.1 second increments.

### Timeout Between Decodes, Different Symbols



## 4.17 Transmit “No Read” Message

---

Scan one of the following bar codes to set an option for transmitting the No Read (NR) characters:

- **Enable No Read** - This transmits the characters NR when a successful decode does not occur before trigger release or the Decode Session Timeout expires.
- **Disable No Read** - This sends nothing to the host if a symbol does not decode.

*NOTE: If you enable Transmit No Read, and also enable Symbol Code ID Character or AIM Code ID Character for Transmit Code ID Character, the engine appends the code ID for Code 39 to the NR message.*

*This does not apply in presentation mode.*

### Enable No Read



### Disable No Read\*



## 4.18 Prefix/Suffix Values

---

You can append a prefix and/or one or two suffixes to scan data for use in data editing. To set a value for a prefix or suffix, scan one of the following bar codes, and then scan four bar codes from [Appendix B, Numeric Bar Codes](#) that correspond to that value. See [Appendix A, ASCII Character Sets](#) for the four-digit codes. When using host commands to set the prefix or suffix, set the key category parameter to 1, and then set the 3-digit decimal value. See [Appendix A, ASCII Character Sets](#) for the four-digit codes. The default prefix and suffix value is 7013 <CR><LF> (Enter key). To correct an error or change a selection, [scan Cancel](#).

*NOTE: To use Prefix/Suffix values, first set the [Scan Data Transmission Format](#).*

### Scan Prefix



### Scan Suffix 1



### Scan Suffix 2



### Data Format Cancel



## 4.19 Scan Data Transmission Format

---

To change the scan data format, scan one of the following bar codes corresponding to the desired format.

*NOTE : If using this parameter do not use ADF rules to set the prefix/suffix.*

**Data As Is\***



<DATA> <SUFFIX 1>



<DATA> <SUFFIX 2>



<DATA> <SUFFIX 1> <SUFFIX 2>



<PREFIX> <DATA >



<PREFIX> <DATA> <SUFFIX 1>



<PREFIX> <DATA> <SUFFIX 2>



<PREFIX> <DATA> <SUFFIX 1> <SUFFIX 2>



## 4.20 Transmit Code ID Character

---

A Code ID character identifies the code type of a scanned bar code. This is useful when decoding more than one code type. In addition to any single character prefix selected, the Code ID character is inserted between the prefix and the decoded symbol.

Select no Code ID character, a Symbol Code ID character, or an AIM Code ID character. For Code ID characters, see Symbol Code Identifiers and AIM Code Identifiers.

### Symbol Code ID Character



### AIM Code ID Character



### None\*



## 4.21 Miscellaneous Scanner Parameters

---

Scan the following bar code to add an Enter key (carriage return/line feed) after scanned data.

**Add Enter Key (Carriage Return/Line Feed)**



Scan the following bar code to add a Tab key after scanned data.

**Tab Key**

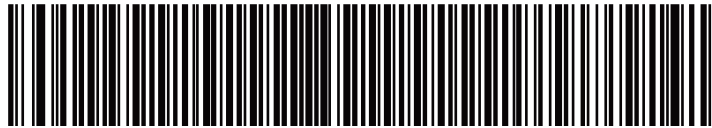

## 4.22 Low Light Scene Detection

---

Scan one of the following bar codes to allow the engine to detect motion in dim to dark illumination environments when in presentation mode:

- **No Low Light Scene Detection** - The engine attempts to detect motion as best it can with the aim pattern and illumination turned off when the engine is idle.
- **Aiming Pattern Low Light Assist Scene Detection** – Illumination is off, but the aim pattern is on when the engine is idle to assist in scene detection.
- **Dim Illumination Low Light Assist Scene Detection** – The aim pattern is off, but illumination is on at a dim level to assist in scene detection.

### No Low Light Assist Scene Detection\*



### Aiming Pattern Low Light Assist Scene Detection



### Dim Illumination Low Light Assist Scene Detection



## **Appendix A – ASCII Character Sets**

### **A-1 ASCII Character Set**

---

ASCII Value (Prefix/Suffix Value)	Full ASCII Code 39 Encode Char	Keystroke	ASCII Character (Applies to RS-232 Only)
1000	%U	CTRL 2	NUL
1001	\$A	CTRL A	SOH
1002	\$B	CTRL B	STX
1003	\$C	CTRL C	ETX
1004	\$D	CTRL D	EOT
1005	\$E	CTRL E	ENQ
1006	\$F	CTRL F	ACK
1007	\$G	CTRL G	BELL
1008	\$H	CTRL H/BACKSPACE <sup>1</sup>	BCKSPC
1009	\$I	CTRL I/HORIZONTAL TAB <sup>1</sup>	HORIZ TAB
1010	\$J	CTRL J	LF/NW LN
1011	\$K	CTRL K	VT
1012	\$L	CTRL L	FF
1013	\$M	CTRL M/ENTER <sup>1</sup>	CR/ENTER
1014	\$N	CTRL N	SO

ASCII Value (Prefix/Suffix Value)	Full ASCII Code 39 Encode Char	Keystroke	ASCII Character (Applies to RS-232 Only)
1015	\$O	CTRL O	SI
1016	\$P	CTRL P	DLE
1017	\$Q	CTRL Q	DC1/XON
1018	\$R	CTRL R	DC2
1019	\$S	CTRL S	DC3/XOFF
1020	\$T	CTRL T	DC4
1021	\$U	CTRL U	NAK
1022	\$V	CTRL V	SYN
1023	\$W	CTRL W	ETB
1024	\$X	CTRL X	CAN
1025	\$Y	CTRL Y	EM
1026	\$Z	CTRL Z	SUB
1027	%A	CTRL [	ESC
1028	%B	CTRL \	FS
1029	%C	CTRL ]	GS
1030	%D	CTRL 6	RS
1031	%E	CTRL -	US
1032	Space	Space	Space
1033	/A	!	!
1034	/B	"	"
1035	/C	#	#
1036	/D	\$	\$
1037	/E	%	%
1038	/F	&	&
1039	/G	'	'
1040	/H	(	(
1041	/I	)	)
1042	/J	*	*
1043	/K	+	+

ASCII Value (Prefix/Suffix Value)	Full ASCII Code 39 Encode Char	Keystroke	ASCII Character (Applies to RS-232 Only)
1044	/L	.	.
1045	-	-	-
1046	.	.	.
1047	/o	/	/
1048	0	0	0
1049	1	1	1
1050	2	2	2
1051	3	3	3
1052	4	4	4
1053	5	5	5
1054	6	6	6
1055	7	7	7
1056	8	8	8
1057	9	9	9
1058	/Z	:	:
1059	%F	:	:
1060	%G	<	<
1061	%H	=	=
1062	%I	>	>
1063	%J	?	?
1064	%V	@	@
1065	A	A	A
1066	B	B	B
1067	C	C	C
1068	D	D	D
1069	E	E	E
1070	F	F	F
1071	G	G	G
1072	H	H	H

ASCII Value (Prefix/Suffix Value)	Full ASCII Code 39 Encode Char	Keystroke	ASCII Character (Applies to RS-232 Only)
1073	I	I	I
1074	J	J	J
1075	K	K	K
1076	L	L	L
1077	M	M	M
1078	N	N	N
1079	O	O	O
1080	P	P	P
1081	Q	Q	Q
1082	R	R	R
1083	S	S	S
1084	T	T	T
1085	U	U	U
1086	V	V	V
1087	W	W	W
1088	X	X	X
1089	Y	Y	Y
1090	Z	Z	Z
1091	%K	[	[
1092	%L	\	\
1093	%M	]	]
1094	%N	^	^
1095	%O	_	_
1096	%W	`	`
1097	+A	a	a
1098	+B	b	b
1099	+C	c	c
1100	+D	d	d
1101	+E	e	e

ASCII Value (Prefix/Suffix Value)	Full ASCII Code 39 Encode Char	Keystroke	ASCII Character (Applies to RS-232 Only)
1102	+F	f	f
1103	+G	g	g
1104	+H	h	h
1105	+I	i	i
1106	+J	j	j
1107	+K	k	k
1108	+L	l	l
1109	+M	m	m
1110	+N	n	n
1111	+O	o	o
1112	+P	p	p
1113	+Q	q	q
1114	+R	r	r
1115	+S	s	s
1116	+T	t	t
1117	+U	u	u
1118	+V	v	v
1119	+W	w	w
1120	+X	x	x
1121	+Y	y	y
1122	+Z	z	z
1123	%P	{	{
1124	%Q		
1125	%R	}	}
1126	%S	~	~
1127			Undefined
7013			ENTER

## A-2 Extended Key Character Set

---

Extended Keypad	Keystroke
7001	Break
7002	Delete
7003	Pg Up
7004	End
7005	Pg Dn
7006	Pause
7007	Scroll Lock
7008	Backspace
7009	Tab
7010	Print Screen
7011	Insert
7012	Home
7013	Enter
7014	Escape
7015	Up Arrow
7016	Dn Arrow
7017	Left Arrow
7018	Right Arrow

## Appendix B – Numeric Barcodes

### B-1 Extended Key Character Set

---

For parameters requiring specific numeric values, scan the appropriately numbered bar code(s).

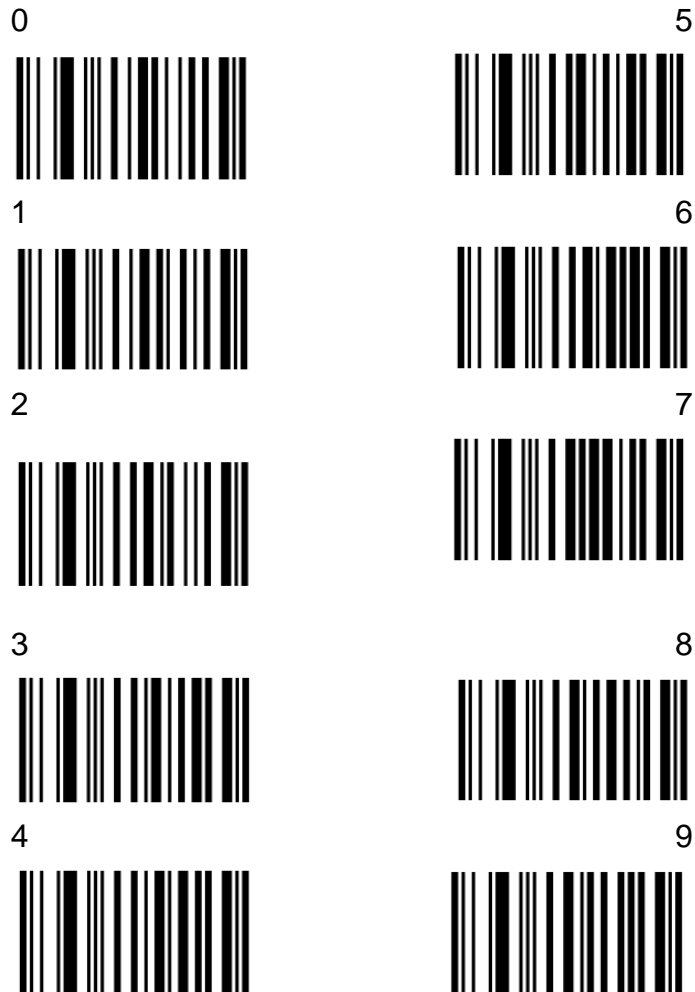

## **B-2 Cancel**

---

To correct an error or change a selection, scan the bar code below.

Cancel



# Appendix C – Alphanumeric BarCodes

## C-1 Alphanumeric Barcodes

---

For parameters requiring specific numeric values, scan the appropriately numbered bar code(s).

Space



#



\$



%



\*



+



-



.



/



!



















“



&



‘	(
	
)	:
	
;	<
	
=	>
	
?	@
	
[	\
	
]	^
	
—	`
	

*NOTE: Do not confuse the following bar codes with those on the numeric keypad.*

0



5



1



6



2



7



3



8



4



9



End of Message



Cancel



A



B



C



D



E



F



G



H



I



J



K

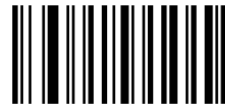

L



M



N



O



P



Q



S



U



W



Y



R



T



V



X



Z



a



b



c



d



e



f



g



h



i



j



k



l



m



n



o



p



q



r



s



t



u



v



w



x



y



z



{



|



}



~



# Appendix D – Programming Reference

## D-1 Symbol Code Identifiers

---

### Symbol Code Characters

Code Character	Code Type
A	UPC-A, UPC-E, UPC-E1, EAN-8, EAN-13
B	Code 39, Code 32
C	Codabar
D	Code 128, ISBT 128, ISBT 128 Concatenated
E	Code 93
F	Interleaved 2 of 5
G	Discrete 2 of 5, or Discrete 2 of 5 IATA
H	Code 11
J	MSI
K	GS1-128
L	Bookland EAN
M	Trioptic Code 39
N	Coupon Code
R	GS1 DataBar Family
S	Matrix 2 of 5
T	UCC Composite, TLC 39
U	Chinese 2 of 5

Code Character	Code Type
V	Korean 3 of 5
X	ISSN EAN, PDF417, Macro PDF417, Micro PDF417
z	Aztec, Aztec Rune
P00	Data Matrix
P01	QR Code, MicroQR
P02	Maxicode
P03	US Postnet
P04	US Planet
P05	Japan Postal
P06	UK Postal
P08	Netherlands KIX Code
P09	Australia Post
P0A	USPS 4CB/One Code/Intelligent Mail
P0B	UPU FICS Postal
P0H	Han Xin
P0X	Signature Capture

## D-2 AIM Code Identifiers

Each AIM Code Identifier contains the three-character string ]cm where:

] = Flag Character (ASCII 93)

c = Code Character

m = Modifier Character

### ■ Aim Code Characters

Code Character	Code Type
A	Code 39, Code 39 Full ASCII, Code 32
C	Code 128, ISBT 128, ISBT 128 Concatenated, GS1-128, Coupon (Code 128 portion)
d	Data Matrix
E	UPC/EAN, Coupon (UPC portion)
e	GS1 DataBar Family
F	Codabar
G	Code 93
H	Code 11
h	Han Xin
I	Interleaved 2 of 5
L	PDF417, Macro PDF417, Micro PDF417
L2	TLC 39
M	MSI
Q	QR Code, MicroQR
S	Discrete 2 of 5, IATA 2 of 5
U	Maxicode
z	Aztec, Aztec Rune
X	Bookland EAN, ISSN EAN, Trioptic Code 39, Chinese 2 of 5, Matrix 2 of 5, Korean 3 of 5, US Postnet, US Planet, UK Postal, Japan Postal, Australia Post, Netherlands KIX Code, USPS 4CB/One Code/ Intelligent Mail, UPU FICS Postal, Signature Capture

## ■ Modifier Characters

The modifier character is the sum of the applicable option values.

Code Type	Option Value	Option
Code 39	0	No check character or Full ASCII processing.
	1	Reader has checked one check character.
	3	Reader has checked and stripped check character.
	4	Reader has performed Full ASCII character conversion.
	5	Reader has performed Full ASCII character conversion and checked one check character.
	7	Reader has performed Full ASCII character conversion and checked and stripped check character.
	Example: A Full ASCII bar code with check character W, A+I+MI+DW, is transmitted as JA7AIMID where 7 = (3+4).	
Trioptic Code 39	0	No option specified at this time. Always transmit 0.
	Example: A Trioptic bar code 412356 is transmitted as JX0412356	
Code 128	0	Standard data packet, no Function code 1 in first symbol position.
	1	Function code 1 in first symbol character position.
	2	Function code 1 in second symbol character position.
	Example: A Code (EAN) 128 bar code with Function 1 character <sup>FNC1</sup> in the first position, AIMID is transmitted as JC1AIMID	
I 2 of 5	0	No check digit processing.
	1	Reader has validated check digit.
	3	Reader has validated and stripped check digit.
	Example: An I 2 of 5 bar code without check digit, 4123, is transmitted as JI04123	
Codabar	0	No check digit processing.
	1	Reader has checked check digit.
	3	Reader has stripped check digit before transmission.
	Example: A Codabar bar code without check digit, 4123, is transmitted as JF04123	
Code 93	0	No options specified at this time. Always transmit 0.
	Example: A Code 93 bar code 012345678905 is transmitted as JG0012345678905	
MSI	0	Check digits are sent.
	1	No check digit is sent.
	Example: An MSI bar code 4123, with a single check digit checked, is transmitted as JM14123	

Code Type	Option Value	Option
D 2 of 5	0	No options specified at this time. Always transmit 0.
		Example: A D 2 of 5 bar code 4123, is transmitted as <b>JS04123</b>
UPC/EAN	0	Standard data packet in full EAN format, i.e., 13 digits for UPC-A, UPC-E, and EAN-13 (not including supplemental data).
	1	Two digit supplemental data only.
	2	Five digit supplemental data only.
	3	Combined data packet comprising 13 digits from EAN-13, UPC-A or UPC-E symbol and 2 or 5 digits from supplemental symbol.
	4	EAN-8 data packet.
		Example: A UPC-A bar code 012345678905 is transmitted as <b>JE00012345678905</b>
Bookland EAN	0	No options specified at this time. Always transmit 0.
		Example: A Bookland EAN bar code 123456789X is transmitted as <b>JX0123456789X</b>
ISSN EAN	0	No options specified at this time. Always transmit 0.
		Example: An ISSN EAN bar code 123456789X is transmitted as <b>JX0123456789X</b>
Code 11	0	Single check digit
	1	Two check digits
	3	Check characters validated but not transmitted.
GS1 DataBar Family		No option specified at this time. Always transmit 0. GS1 DataBar-14 and GS1 DataBar Limited transmit with an Application Identifier "01". Note: In GS1-128 emulation mode, GS1 DataBar is transmitted using Code 128 rules (i.e., JC1).
		Example: A GS1 DataBar-14 bar code 0110012345678902 is transmitted as <b>Je00110012345678902</b> .

Code Type	Option Value	Option
EAN.UCC Composites (GS1 DataBar, GS1-128, 2D portion of UPC composite)		Native mode transmission. Note: UPC portion of composite is transmitted using UPC rules.
	0	Standard data packet.
	1	Data packet containing the data following an encoded symbol separator character.
	2	Data packet containing the data following an escape mechanism character. The data packet does not support the ECI protocol.
	3	Data packet containing the data following an escape mechanism character. The data packet supports the ECI protocol.
		GS1-128 emulation Note: UPC portion of composite is transmitted using UPC rules.
	1	Data packet is a GS1-128 symbol (i.e., data is preceded with ]JC1).
PDF417, Micro PDF417	0	Reader set to conform to protocol defined in 1994 PDF417 symbology specifications. <b>Note:</b> When this option is transmitted, the receiver cannot reliably determine whether ECIs have been invoked or whether data byte 92 <sub>DEC</sub> has been doubled in transmission.
	1	Reader set to follow the ECI protocol (Extended Channel Interpretation). All data characters 92 <sub>DEC</sub> are doubled.
	2	Reader set for Basic Channel operation (no escape character transmission protocol). Data characters 92 <sub>DEC</sub> are not doubled. <b>Note:</b> When decoders are set to this mode, unbuffered Macro symbols and symbols requiring the decoder to convey ECI escape sequences cannot be transmitted.
	3	The bar code contains a GS1-128 symbol, and the first codeword is 903-907, 912, 914, 915.
	4	The bar code contains a GS1-128 symbol, and the first codeword is in the range 908-909.
	5	The bar code contains a GS1-128 symbol, and the first codeword is in the range 910-911.
		Example: A PDF417 bar code ABCD, with no transmission protocol enabled, is transmitted as ]L2ABCD.

Code Type	Option Value	Option
Data Matrix	0	ECC 000-140, not supported.
	1	ECC 200.
	2	ECC 200, FNC1 in first or fifth position.
	3	ECC 200, FNC1 in second or sixth position.
	4	ECC 200, ECI protocol implemented.
	5	ECC 200, FNC1 in first or fifth position, ECI protocol implemented.
	6	ECC 200, FNC1 in second or sixth position, ECI protocol implemented.
MaxiCode	0	Symbol in Mode 4 or 5.
	1	Symbol in Mode 2 or 3.
	2	Symbol in Mode 4 or 5, ECI protocol implemented.
	3	Symbol in Mode 2 or 3, ECI protocol implemented in secondary message.
QR Code	0	Model 1 symbol.
	1	Model 2 / MicroQR symbol, ECI protocol not implemented.
	2	Model 2 symbol, ECI protocol implemented.
	3	Model 2 symbol, ECI protocol not implemented, FNC1 implied in first position.
	4	Model 2 symbol, ECI protocol implemented, FNC1 implied in first position.
	5	Model 2 symbol, ECI protocol not implemented, FNC1 implied in second position.
	6	Model 2 symbol, ECI protocol implemented, FNC1 implied in second position.
Aztec	0	Aztec symbol.
	C	Aztec Rune symbol.
Han Xin	0	Generic data, no special features are set. The transmitted data does not follow the AIM ECI protocol.
	1	ECI protocol enabled. There is at least one ECI mode encoded. Transmitted data must follow the AIM ECI protocol.